



Packaging machines



User Manual

www.audion.com

All-In Sealer

D 552 AH / D 552 AHS

D 552 AH(S) ENG Rev.04
DOC 004G1312

All rights reserved.

No part of this publication may be reproduced and/or published by means of print, photocopy, or in any other way, without prior written permission from Audion Elektro BV.

Audion Elektro BV reserves the right to modify the machine and/or change the operating manual without prior notice.

Audion Elektro BV is not liable for any damage caused by specifications deviating from the standard version.

Although this manual was compiled with the utmost care, Audion Elektro BV does not accept any liability for any mistakes it may contain and/or the consequences of any incorrect interpretation of its contents.

Audion Elektro BV is not liable for any damage or problems resulting from the use of parts other than original parts. If this manual does not provide instructions for certain repairs, adjustments or maintenance, please contact your dealer or Audion Elektro BV.



Please read this operating manual carefully before using the sealer or carrying out maintenance on it.

The sealer is part of the Audion product range. We also provide:

- Impulse sealers.
- Heat sealers.
- Continuous sealers.
- Vacuum sealers.
- Vacuum chambers.
- Shrink machines.
- Validatable sealers.
- Form, fill and seal machines.

Since its inception in 1947, Audion has gained a lot of experience and expertise with a wide variety of sealing and packaging machines. Our solutions for packaging problems are unique. Our many years of experience together with our modern production, assembly and testing methods ensure that our packaging machines meet the highest quality standards. We can also customise the machines according to your specific requirements.

Audion is the right supplier for a packaging machine that is geared to your requirements.

Table of Contents

| | | |
|-------|---|----|
| 1 | Introduction..... | 6 |
| 1.1 | Manufacturer | 6 |
| 1.2 | Machine Type Plate..... | 6 |
| 1.3 | Warranty Conditions and Liability..... | 6 |
| 2 | Safety..... | 8 |
| 2.1 | Symbols Used in This Manual..... | 8 |
| 2.2 | User..... | 8 |
| 2.2.1 | Operating Personnel..... | 8 |
| 2.2.2 | Maintenance Personnel..... | 8 |
| 2.3 | Safety Instructions | 9 |
| 2.3.1 | General Safety Instructions..... | 9 |
| 2.3.2 | What to do in case of Fire..... | 10 |
| 2.3.3 | Use for Special Applications | 10 |
| 2.4 | Safety Provisions..... | 11 |
| 2.5 | Safety symbols..... | 11 |
| 3 | Installation..... | 12 |
| 3.1 | Unpacking the Sealer | 12 |
| 3.2 | Placing the Sealer..... | 12 |
| 3.3 | Connecting the Sealer..... | 12 |
| 3.4 | Adjusting the Sealer..... | 13 |
| 3.4.1 | Adjusting the Conveyor Belt Height | 13 |
| 3.4.2 | Adjusting the Conveyor Belt Slope..... | 14 |
| 3.4.3 | Adjusting the Horizontal Distance for the Sealing Unit..... | 14 |
| 3.4.4 | Adjusting the Sealing Unit Height | 15 |
| 4 | Description of the Sealer | 16 |
| 4.1 | Function | 16 |
| 4.2 | Overview of the Sealer..... | 17 |
| 4.3 | Control Panel | 18 |
| 4.3.1 | Cool Run mode | 19 |
| 5 | Operation..... | 20 |
| 5.1 | Preparing the Sealer for Production..... | 20 |
| 5.1.1 | Switching on the Sealer | 20 |
| 5.1.2 | Setting the Sealing Temperature and the Conveyor Belt Speed | 20 |
| 5.1.3 | Switching on the heating, the cooling and the fan | 21 |
| 5.1.4 | Starting the Sealer | 22 |
| 5.2 | Sealing | 22 |
| 5.3 | Stopping the Sealer (STANDBY mode)..... | 23 |
| 5.4 | Emergency stop..... | 23 |
| 5.4.1 | Restarting After an Emergency Stop | 24 |
| 5.5 | Switching Off the Sealer Completely | 24 |
| 6 | Troubleshooting..... | 25 |
| 7 | Maintenance..... | 27 |
| 7.1 | Maintenance Schedule..... | 27 |

| | | |
|-------|---|----|
| 7.1.1 | Daily maintenance | 27 |
| 7.1.2 | Weekly maintenance | 27 |
| 7.1.3 | Annual maintenance..... | 27 |
| 7.2 | Switching Off the Sealer and Opening the Protective Cover | 28 |
| 7.3 | Replacing the PTFE Belts | 28 |
| 7.4 | Replacing V-belts..... | 30 |
| 7.5 | Adjusting the V-belts..... | 31 |
| 7.6 | Replacing the heating elements | 31 |
| 7.7 | Adjusting the Contact Force of the Heating Blocks | 34 |
| 7.8 | Adjusting the Contact Force of the Press Rollers | 34 |
| 7.9 | Adjusting the Contact Force for the Cooling Plates..... | 35 |
| 7.10 | Adjusting the Contact Force of the After-press Rollers..... | 35 |
| 7.11 | Adjusting the Conveyor Belt Tension..... | 36 |
| 7.12 | Motor Set-up..... | 36 |
| 7.13 | Correction factor..... | 37 |
| 7.14 | Reset to factory settings | 37 |
| 8 | Disposing of the Sealer | 38 |
| 8.1 | WEEE Directive..... | 38 |
| 8.2 | Correct Disposal for Reuse | 38 |
| A | Technical Information..... | 39 |
| A.1. | Dimension drawing | 39 |
| A.2. | Technical Data | 40 |
| B | Electrical Diagram | 41 |
| C | Spare Parts | 43 |
| C.1. | Wearing parts | 43 |
| C.2. | Exploded views | 44 |
| D | Log | 60 |
| D.1. | Maintenance Log..... | 60 |
| E | EC Declaration..... | 61 |
| F | Options..... | 62 |

1 Introduction

1.1 Manufacturer

The sealer was manufactured by:

| |
|--------------------------|
| Audion Elektro BV |
| Hogeweyselaan 235 |
| 1382 JL Weesp |
| The Netherlands |

| | |
|------------|-------------------|
| Telephone: | +31 (0)294 491717 |
| Fax: | +31 (0)294 491761 |

| | |
|--------|------------------|
| Email: | Export@audion.nl |
| Web: | www.audion.com |

1.2 Machine Type Plate

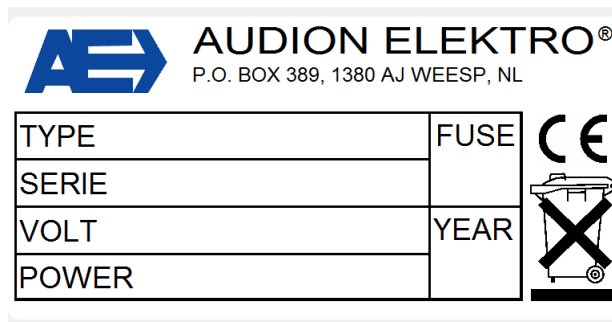

The sealer has a CE marking. This means that the sealer meets the fundamental health and safety requirements of the European Communities.

1.3 Warranty Conditions and Liability

Subject to the limitations stated below, we provide a 12-month warranty for the products we deliver. This warranty is limited to manufacturing defects and therefore does not cover any malfunctions caused by any form of wear, or any part of the delivered product that is subject to wear.

- The warranty we provide for parts or accessories purchased from third parties is limited to the warranty the third-party provided to us.
- The warranty is void if the other party and/or any third parties engaged by them use the product in a way it is not intended for.
- The warranty is also void if the other party, and/or any third parties engaged by them carries out work and/or modifications on the delivered product.
- Any parts we replace in order to meet our warranty obligations become our property.

- Should the other party not meet obligation resulting from the agreement entered into between the parties in whole or in part or in a timely manner, we are not obliged to provide warranty for as long as that situation continues.

We exclude all liability to the extent that the liability is not regulated by law. Our liability will never exceed the total amount of the order in question.

Subject to the generally applicable legal rules of public order and good faith, we are not obliged to pay compensation to the other party or any third party for damages of any nature whatsoever, incurred directly or indirectly, including trading loss and damage to movable or immovable property or persons.

In no case are we liable for any damage resulting from or caused by using the delivered product or its unsuitability for the purpose for which the other party purchased it.

2 Safety

2.1 Symbols Used in This Manual

The following symbols are used in this user manual:



A tip on how a task can be carried out more efficiently.



Instructions for carrying out a task in the correct manner.



Danger of injury to the user or damage to the sealer if the instructions are not observed.

2.2 User



The sealer should only be operated by authorised personnel.



Improper use of the sealer may lead to serious personal injury and considerable material damage.



Keep bystanders at a distance. Do NOT allow unauthorised personnel to operate the sealer.

2.2.1 Operating Personnel

The company using the machine has organised a training session to inform its operating personnel of the potential risks of unprofessional behaviour while carrying out their tasks.



Installation, maintenance and repair require specialised knowledge, which is why these tasks should only be performed by maintenance personnel.



Observe the safety instructions in this user manual. Failure to observe the safety instructions may cause unacceptable risks.

The operating personnel must be familiar with all chapters of this user manual with the exception of 'Installation' and 'Maintenance'. Always observe the following safety instructions before using the sealer or carrying out any maintenance work.

2.2.2 Maintenance Personnel

These personnel's professional training, knowledge and experience, and knowledge of the manufacturer's terms enable them to carry out the assigned work and immediately recognise any risks that may arise.



Observe the safety instructions in this user manual. Failure to observe the safety instructions may cause unacceptable risks.

The maintenance personnel must be familiar with all chapters of this user manual. Always observe the following safety instructions before using the sealer or carrying out any maintenance work.

2.3 Safety Instructions

The sealer meets the fundamental health and safety requirements of the European Community. This means that the sealer can be operated and maintained safely if all safety instructions are carefully observed. However, improper or careless use can create dangerous situations.



Observe the safety instructions in this user manual. Always remain alert to dangerous situations and avoid any improper or careless use.

2.3.1 General Safety Instructions

Observe the following general safety instructions:

- Tie back long hair.
- Do not wear loose clothing or jewellery.



- Always wear the personal protective equipment (PPE) prescribed by the company, such as safety shoes, gloves and goggles.



Use the PPE required on the shop floor, such as safety shoes, gloves and goggles and/or hearing protection, in particular when carrying out maintenance work.

- Check the operation of the sealer every day.
- Keep your hands away from dangerous parts of the sealer.
- Always leave protective covers in place during production.
- Never bypass or deactivate any safety provisions.
- The sealer should never be operated or maintained by people who are under the influence of alcohol, medication and/or drugs.
- Only use sealable material that is suitable for the sealer.
- The user is obliged to observe the normally applicable hygienic measures.
- If you are not sure whether the sealer is working properly, switch it off immediately and consult the maintenance personnel.
- Both the user and the sealer must be supervised while the sealer is in use.
- Do not switch the sealer back on until the malfunction has been repaired.
- Should any liquid or foreign object enter the machine, switch off the sealer and immediately remove the plug from the wall socket and have the sealer checked by maintenance personnel before using it again.

- Should an unusual event occur, such as the development of smoke, remove the plug from the socket immediately and have the sealer checked by maintenance personnel before using it again.
- Remove the plug from the socket before carrying out any maintenance work.
- Never open the sealer's housing while it is connected to the mains power.
- Do not use any water, abrasive cleaning agents, chemical solvents or other liquids when cleaning the sealer.

2.3.2 What to do in case of Fire



NEVER use water to extinguish a fire. This may result in life-threatening situations because the sealer may be electrically live.

Should the sealer catch fire, never use water to extinguish the fire. Because the machine is live, this may result in life-threatening situations. A fire extinguisher must be within reach when the sealer is in use. The following types of fire extinguishers are suitable to extinguish a burning sealer.

- Powder extinguisher.
- Foam extinguisher.

2.3.3 Use for Special Applications



If the machine is used in a special environment, the company using the machine must ensure that any instructions specific to that environment are observed.

- If the machine is used in a sterile environment or cleanroom, the company using the machine must ensure that any instructions specific to that environment are observed.
- If the machine is used for the packaging of medical instruments, the company using the machine must ensure that any instructions specific to that environment are observed.
- If the machine is used for the packaging of food, the company using the machine must ensure that any instructions specific to that environment are observed.

2.4 Safety Provisions

The sealer has the following safety provisions:

1. Safety covers.
 - Electrical and mechanical parts in the housing are protected.
2. Metal parts are earthed.
 - No dangerous voltage can develop between (external) metal parts and the earth.
3. Fuse in 230 V circuit.
 - If the maximum current is exceeded, the fuse will blow, cutting off the power supply.
4. Emergency stop button
 - In the event of a hazard, this can be used for switching off the sealer immediately and completely.

2.5 Safety symbols

The following safety symbols have been applied on the All-In Sealer:

Hot surfaces

On the front of the All-In Sealer on the cover.

There are heating elements and it may therefore get hot.



3 Installation

3.1 Unpacking the Sealer

Check the following when unpacking the sealer:

1. Have all parts and accessories been delivered?
 - Sealer
 - User manual



The sealer is packaged in environmentally friendly material that may be disposed of as ordinary household waste.

Keep the crate and the packaging material so that the sealer can be transported safely again if necessary.

3.2 Placing the Sealer

1. Move the sealer to the desired location.
2. Lock the wheels by pressing the brakes down with your foot.



3.3 Connecting the Sealer

1. Check that the main switch is in the '0' position.



2. Insert the plug in the wall socket.



3.4 Adjusting the Sealer

The following adjustments can be made:

- The height of the conveyor belt with respect to the sealing unit; to adjust for the height of the bags.
- The slope of the conveyor belt, to prevent the product from falling out of the bags.
- The horizontal distance between conveyor belt and sealing unit; to adjust for the positioning of the bags on the conveyor belt.
- The height of conveyor belt with respect to the floor, to adjust the working height.

3.4.1 Adjusting the Conveyor Belt Height

The conveyor belt height can be adjusted with respect to the sealing unit as follows:

1. Loosen the two locking bolts at the sides by a few turns.
2. Set the height of the conveyor belt using the crank.
3. Tighten both locking bolts again.

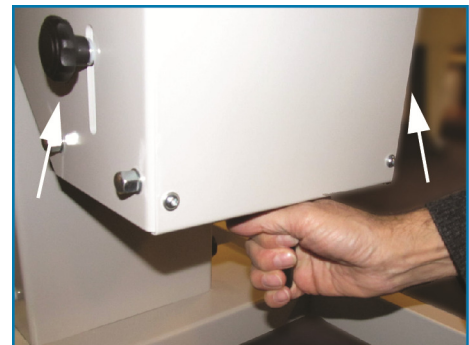

The conveyor belt height must be set to roughly half the thickness of the packages that are to be sealed.

3.4.2 Adjusting the Conveyor Belt Slope

The conveyor belt slope can be adjusted as follows:

1. Undo the two locking bolts completely.

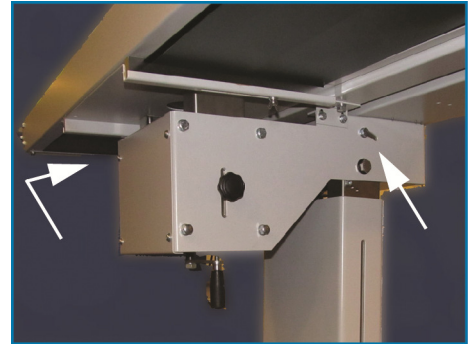

2. Remove the two hex socket bolts.
3. Adjust the angle of slope of the conveyor belt by tilting it.
4. Tighten both hex socket bolts again in the appropriate screw holes.
5. Tighten both locking bolts again in the appropriate screw holes.

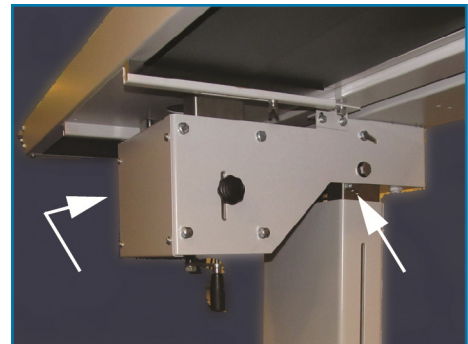

The conveyor belt slope should be set so that the product does not fall out of the bags that are being sealed.

3.4.3 Adjusting the Horizontal Distance for the Sealing Unit

The horizontal distance of the sealing unit with respect to the conveyor belt is adjusted as follows:

1. Loosen both locking bolts a few turns.
2. Adjust the position of the sealing unit with respect to the conveyor belt by shifting the conveyor belt.
3. Tighten both locking bolts again.

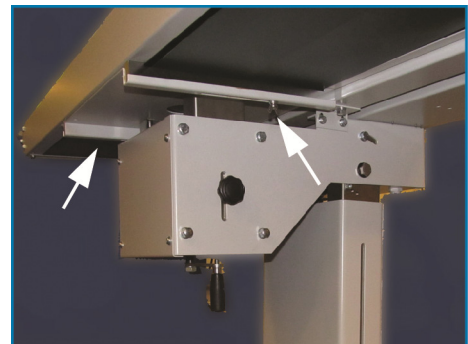

The positions of the sealing unit and conveyor belt must be set so that the bags that are to be sealed are in the middle of the conveyor belt.

3.4.4 Adjusting the Sealing Unit Height

The sealing unit height can be adjusted as follows:

1. Loosen the two locking bolts at the sides by a few turns.
2. Unfold the crank.
3. Set the sealing unit height by turning the crank.
4. Tighten both locking bolts again.
5. Fold the crank back up again.

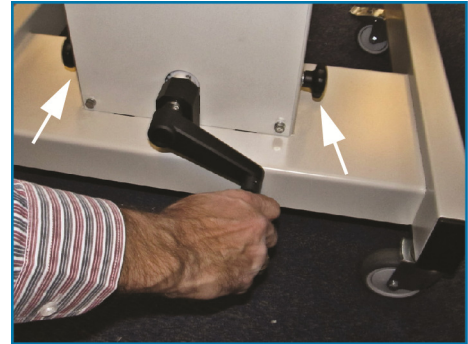

The height of the conveyor belt must line up with the infeed and outfeed belts.

4 Description of the Sealer

4.1 Function

The All-In Sealer is a band sealer for packaging a wide variety of products in large quantities. The products are packaged in ready-to-use bags and then sealed. The sealer can be used for sealing ready-made bags made of polyethylene (PE), polypropylene (PP), thin PVC and various laminates with thicknesses of between 20µm and 150µm.



Never use the All-In Sealer for any other purpose.

The sealer is not suitable for the following applications:

- use in cleanroom environments
- use in medical or sterile environments
- use in explosive environments
- use with toxic, suffocating or irritant gases
- use in dusty environments

4.2 Overview of the Sealer



1. Housing
2. Control panel
3. Conveyor belt
4. Setting the distance and height of the conveyor belt with respect to the sealing unit
5. Height adjustment
6. Frame with wheels

The sealer consists of a wheeled frame on which there is a conveyor belt and a housing. The housing comprises the electrical and drive components; the operating panel is mounted on top of the housing.

The conveyor belt transports the bags that are to be sealed past the heating blocks, the press rollers, the cooling plates and the after-press rollers that are located inside the housing.

The height of the conveyor belt can be adjusted to let it line up seamlessly with the infeed and outfeed belts. The vertical distance between the conveyor belt and the housing can also be adjusted so that bags of various different heights can be sealed. The horizontal position of the conveyor belt with respect to the sealing unit can be adjusted to position the bags as centrally as possible on the conveyor belt.

4.3 Control Panel

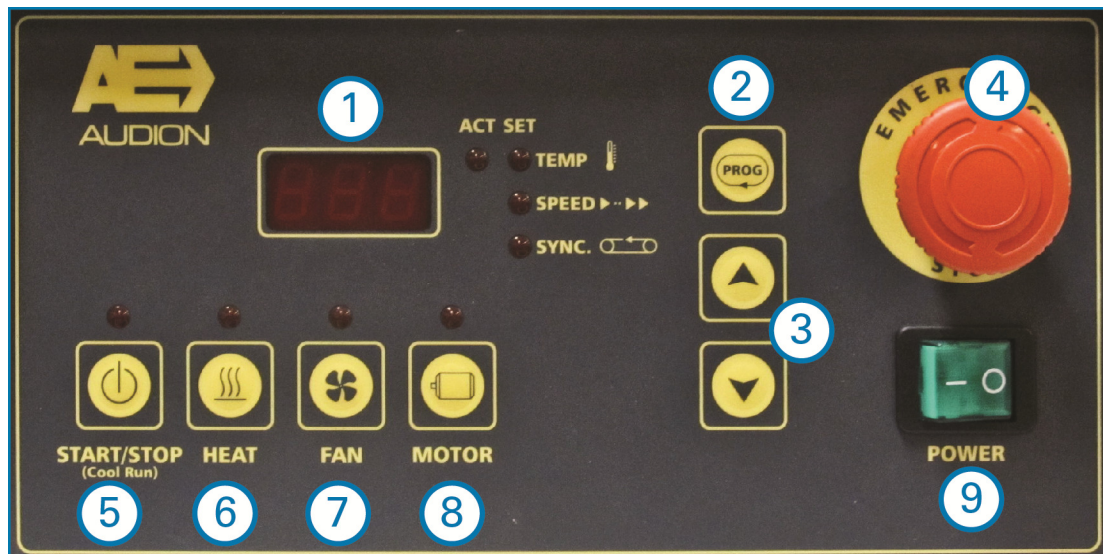

- | | |
|--------------------------|--|
| 1. Display | Gives the current sealing temperature, speed or an error message. The setpoint value will be shown while the settings are being adjusted. |
| 2. Prog | Press this to change the settings menu of the sealer. A LED next to the button will show which setting is being adjusted: Temp, the sealing temperature. Speed, the conveyor belt speed. |
| 3. Up/Down | Press these to increase or reduce a setting. |
| 4. Emergency stop button | If a dangerous situation occurs, this will switch off the sealer immediately and completely. |
| 5. Start/Stop | Press to start or stop the sealer. A LED above the button shows whether the sealer is switched on or off. If the current sealing temperature is above 80°C when the sealer is switched off, it will first switch to 'cool run' mode. |
| 6. Heat | Press this to switch the heating on or off. A LED above the button indicates whether the function is switched on or off. |
| 7. Fan | Press this to switch the fan on or off. A LED above the button indicates whether the function is switched on or off. |
| 8. Motor | Press this to switch the motor on or off. A LED above the button shows whether the function is switched on or off. |
| 9. Main switch | Switch for turning the sealer on or off. |

4.3.1 Cool Run mode

The 'cool run' mode avoids burnt spots on the PTFE belts. After the machine has been stopped, the heater is switched off; however, the fan and the motor will continue to run. When the sealing temperature has dropped below 80°C, the sealer is switched to standby mode. The fan and the motor will then also be switched off.

5 Operation

5.1 Preparing the Sealer for Production

5.1.1 Switching on the Sealer

Switch the sealer on as follows:

1. Set the MAIN SWITCH to '1'.
2. Turn the EMERGENCY STOP BUTTON clockwise if necessary to reset it.



Put the plug in the socket first if necessary.

5.1.2 Setting the Sealing Temperature and the Conveyor Belt Speed

The sealing temperature and conveyor speed can be adjusted as follows:

1. Press the prog button until the TEMP LED is lit.
2. Press the arrow keys to raise or lower the sealing temperature.

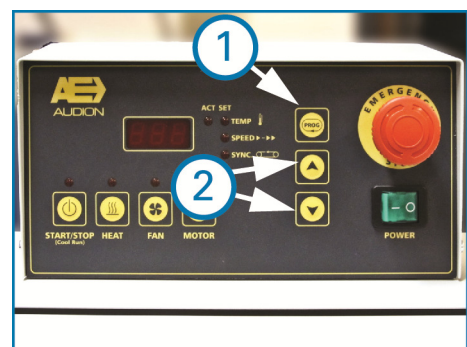

The guideline sealing temperature is 100°C

3. Press the PROG button until the SPEED LED is lit.
4. Press the ARROW button to increase or reduce the speed of the conveyor belt.

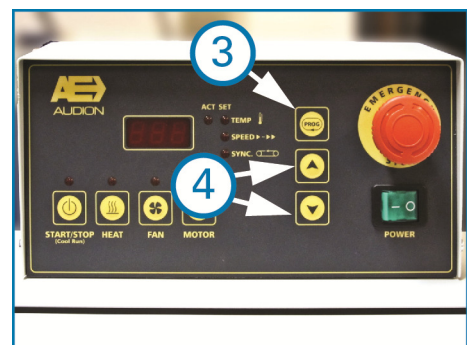

The guideline value for the conveyor belt speed is 50.

- Press the PROG button until the current sealing temperature is shown in the display again.



The TEMP LED will blink if the setpoint temperature differs from the current sealing temperature by more than 5°C.

Make a number of trial seals and readjust the sealing temperature and speed as necessary.

5.1.3 Switching on the heating, the cooling and the fan

Switch on the heating, the cooling and the fan as follows:

- Press the HEAT button.
- Press the MOTOR button.



The heating and the transport motor must always be switched on before use.

- Press the FAN button if necessary.



If a paper or aluminium laminate film is being used, the FAN does not have to be switched on.

Do be sure to switch on the fan when using PE films.

5.1.4 Starting the Sealer

Start the sealer as follows:

1. Press the START/STOP button.
2. Wait until the TEMP LED has stopped blinking.



The sealer has now reached the set temperature and is ready for sealing.

5.2 Sealing

Bags are sealed as follows:

1. Place the bags on the conveyor belt and guide the bag into the infeed guide.



Make a number of trial seals first to check that the settings are correct. Adjust the sealing temperature and conveyor belt speed as necessary.

5.3 Stopping the Sealer (STANDBY mode)

The sealer can be stopped and put in Standby mode after use as follows:

1. Press the START/STOP button.



The sealer now switches to Standby mode and the display shows "---". If the sealing temperature is above 80°C, the sealer will first switch to COOL RUN mode. The heating is switched off and the fan and motor continue to run until the sealing temperature has dropped to below 80°C. The display will alternate between "c-r" and the current sealing temperature.

The sealer is then switched to STANDBY mode.



If the sealer is not going to be used for a lengthy period, it is better to turn it off completely using the MAIN SWITCH.

5.4 Emergency stop

In the event of an emergency, switch the sealer off completely as follows:

1. Press the EMERGENCY STOP BUTTON.



In emergency situations, always use the emergency stop button immediately.

Do not use the emergency stop button to switch off the sealer under normal circumstances.

5.4.1 Restarting After an Emergency Stop

The sealer can be restarted after an emergency stop as follows:



Make sure that whatever caused the emergency stop has been corrected before restarting the sealer.

1. Turn the EMERGENCY STOP BUTTON clockwise to reset it.
2. Press the START/STOP button.

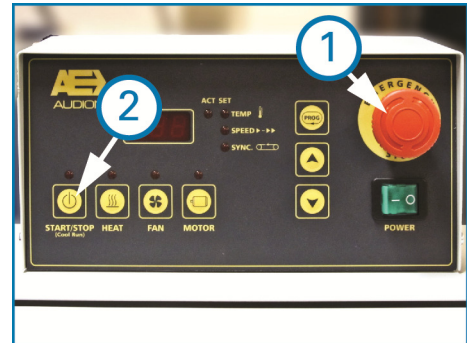

The sealer is now ready to be used again. The 'TEMP' LED may possibly be blinking; in that case, the sealer has to heat up again first.

5.5 Switching Off the Sealer Completely

The sealer can be switched off completely as follows:

1. Set the MAIN SWITCH to '0'.



Make sure that the sealer is in Standby mode before it is switched off completely (see 'Stopping the Sealer (STANDBY mode)').

6 Troubleshooting



Troubleshooting may only be performed by authorised maintenance personnel.



In the event of a malfunction, always remove the plug from the socket before attempting to solve the problem.



If the problem cannot be solved using the following troubleshooting table, please contact your dealer or Audion.

| Problem | Cause | Solution |
|----------------------------------|--|--|
| The sealer does not do anything. | The main switch is set to '0'. | Switch the sealer on. |
| | The plug is not inserted into the wall socket or has not been inserted properly. | Put the plug in the socket properly. |
| | The power has been cut. | Check the power supply. |
| | The emergency stop button has been pressed. | Reset the emergency stop button. |
| | Internal fault. | Contact your dealer or Audion. |
| The seal is not neat and tidy. | The sealing temperature is not set correctly. | Readjust the sealing temperature. |
| | The conveyor belt speed is not set correctly. | Readjust the conveyor belt speed. |
| | The heating blocks and/or the PTFE belts are dirty. | Clean the heating blocks and/or the PTFE belts. |
| | The seal is not being cooled properly. | Switch the cooling on. |
| | The heating block, the cooling plate and/or the press rollers are still raised. | Put the heating block, cooling plate and/or press rollers back in the lowest position. |
| | The PTFE belts are worn. | Replace the PTFE belts. |
| The cooling is not working | The fan is not on. | Switch the fan on. |
| | The cooling plate position is too high. | Adjust the cooling plate correctly. |
| | Internal fault | Contact your dealer or Audion. |
| Error code E1 | Incorrect frequency setting (50 Hz or 60 Hz - PCB jumpers). | Check the main frequency and set the PCB jumpers correctly. |
| Error code E2 | Loose wire to the temperature sensor (Pt100). | Check the connections in the temperature sensor wiring (Pt100). |
| Error code E3 | Short circuit in the temperature sensor (Pt100). | Replace the temperature sensor (Pt100). |

All-In Sealer

D 552 AH / D 552 AHS

| | | |
|----------------------------------|--------------------------|--------------------------------|
| The conveyor belt is not moving. | The speed is set to '0'. | Set the speed higher. |
| | Internal fault. | Contact your dealer or Audion. |

7 Maintenance



Maintenance should only be performed by authorised maintenance personnel.



Always remove the plug from the socket before carrying out any maintenance work.



Do not use any water, abrasive cleaning agents, chemical solvents or other liquids when cleaning the machine.



The maintenance schedule is based on normal use. The frequency of maintenance must be increased if the machine is used intensively, or under extreme conditions.



Always keep a log of all maintenance work. An example is provided as an annex.

7.1 Maintenance Schedule

7.1.1 Daily maintenance



Daily maintenance should be carried out by the operating personnel (see Foreword)

| Part | Work |
|----------------|--|
| PTFE belts | Check that the PTFE belts are clean. Clean with a damp cloth if necessary. |
| Heating blocks | check that the heating blocks are clean. Clean with a damp cloth if necessary. |

7.1.2 Weekly maintenance



Weekly maintenance should be carried out by authorised maintenance staff (see Foreword).

| Part | Work |
|---------------|--|
| Drive | Check the rotating parts and chains. Lubricate as necessary. |
| V-belts | Check the V-belts for cracks and check the tension. |
| Conveyor belt | Check the conveyor belt for cracks and check its tension. |
| Cleaning | Clean the sealer with a damp cloth and mild soap (for example, all-purpose cleaner). |

7.1.3 Annual maintenance



Annual maintenance should be carried out by authorised maintenance staff (see Foreword).

| Part | Work |
|-----------------|---|
| Earthing system | Check that the earthing complies with NEN 3140 or EN 50110-1. |

7.2 Switching Off the Sealer and Opening the Protective Cover

Open the protective cover as follows:

1. Set the main switch to '0'.
2. Remove the plug from the socket.



Never carry out maintenance on the All-In Sealer while it is live.

3. Loosen the bolt at the back.
4. Loosen the two bolts on the top.
5. Open the protective cover.



Warning! The heating blocks may still be hot, even if the sealer has been switched off for a while.

7.3 Replacing the PTFE Belts



Warning! The heating blocks may still be hot, even if the sealer has been switched off for a while.

Replace the PTFE belts as follows:

1. Move the cooling plate, the after-press roller and the heating block to their uppermost position.

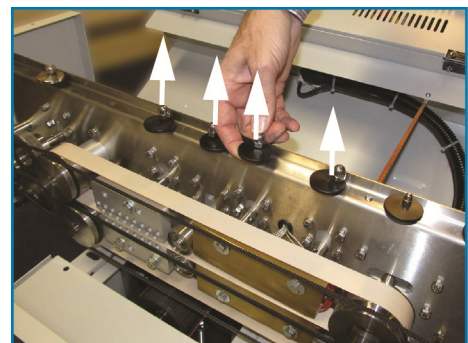



Pull the lifting pin up and turn the lifting plate in such a way that it protrudes above the edge of the protective cover.

2. Push the two tension rollers inwards until they lock in place.

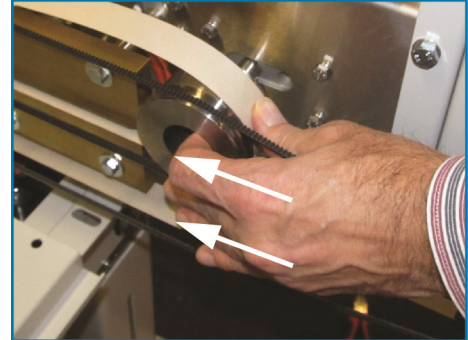

When a tension roller is pushed inwards, the locking pin falls into a recess, which prevents the tension roller from springing back.

3. Remove the V-belts by pushing them off the pulleys with a rotating motion.

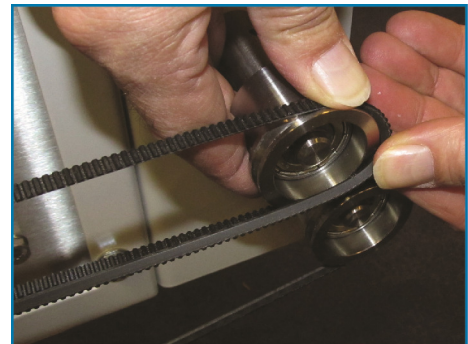

4. Remove the old PTFE belts and put the new ones in place.

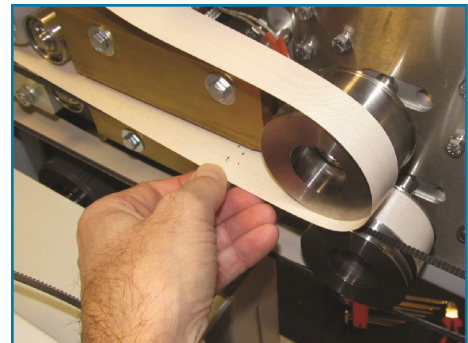

Make sure there are no creases or folds in the PTFE belts. This can make them break during use.

5. Pull the tension roller locking pins upwards and let the tension rollers spring back gently.



Make sure that the PTFE belts run smoothly over the rollers.

6. Place the V-belts back over the pulleys.

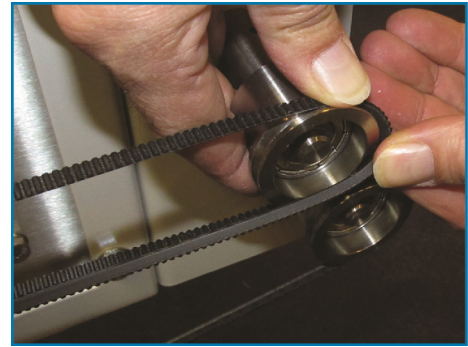

Make sure that the V-belts run smoothly over the rollers, with the serrated side facing outwards.

7. Move the cooling plates, the after-press roller and the heating block back to their lowest position.

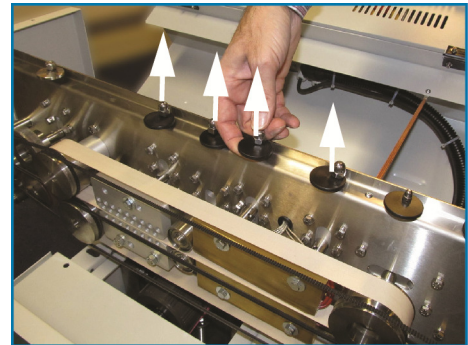

Pull the lifting pin up and turn the lifting plate so that the lifting pin can go back down all the way again.

7.4 Replacing V-belts

Replace the V-belts as follows:

1. Remove the V-belts by pushing them off the pulleys.
2. Put the new V-belts back over the pulleys.

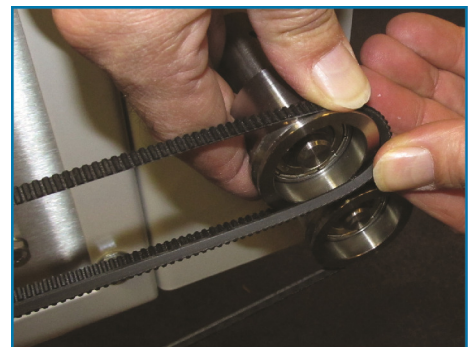

Make sure that the V-belts run smoothly over the rollers, with the serrated side facing outwards.

7.5 Adjusting the V-belts

The V-belts can be adjusted as follows:

1. Loosen the nut at the back of the shaft by one full turn.



Do not undo the nut completely, or else the tension roller will not stay suspended.

2. Slide the tension roller to the left or right to increase or decrease the V-belt tension respectively.
3. Tighten the bolt at the back of the shaft again.

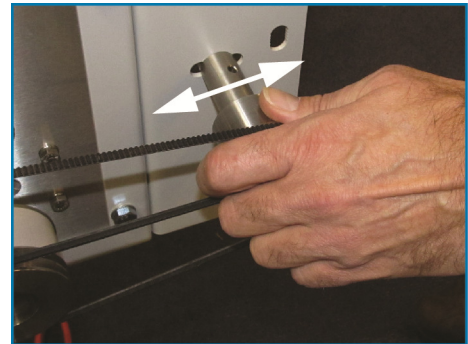

The long belts must be able to move up and down about 1 cm in the middle; for the short belts, the play must be 0.5 cm.

A V-belt that has to be tensioned frequently is worn and should be replaced.

7.6 Replacing the heating elements

Replace the heating elements as follows:

1. Loosen the clamping screws in the terminal block.
2. Pull the wires out of the terminal block.
3. Cut the tie-wraps away.

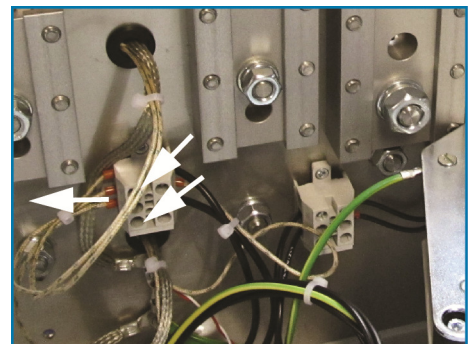

4. Move the heating block to its uppermost position.

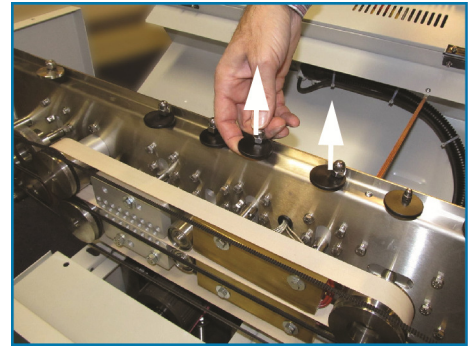

Pull the lifting pin up and turn the lifting plate in such a way that it protrudes above the edge of the protective cover.

5. Loosen the mounting bolts.
6. Remove the heating block from the machine.

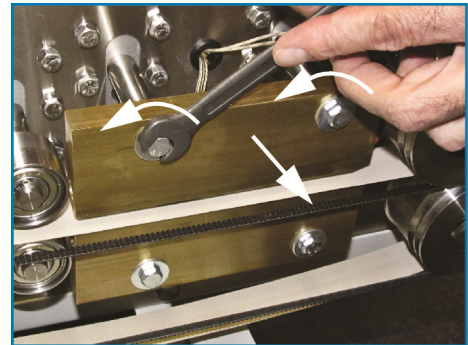

7. Loosen the hex socket bolt at the back of the heating block.
8. Take the heating element out of the heating block.
9. Put a new heating element in place.
10. Carefully tighten the hex socket bolt at the back of the heating block.

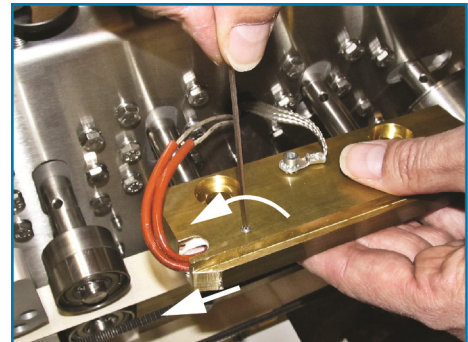

Do not tighten the hex socket bolt too far, or the heating element may get damaged.

11. Push the connecting wires through the opening.
12. Put back the heating blocks.
13. Tighten the mounting bolts again.

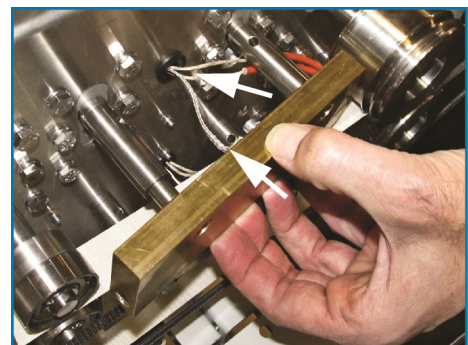

Note that the upper heating block should still be able to move up and down a little bit after the mounting bolts are tightened.

14. Insert the connecting wires back in the terminal block.

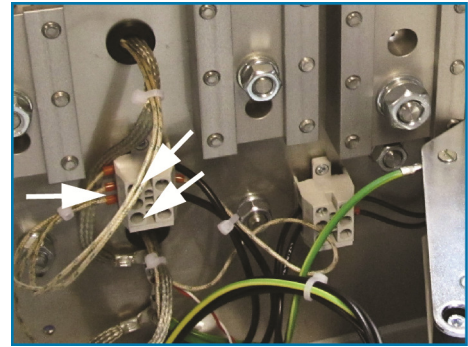

15. Tighten the terminal block screws again.

16. Fix the connecting wires in place again with tie-wraps.

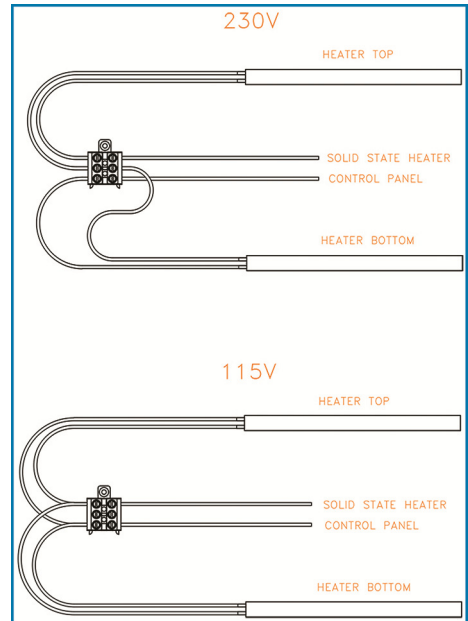

Take care to connect the wires in the correct positions.

17. Move the heating block back to its lowest position.

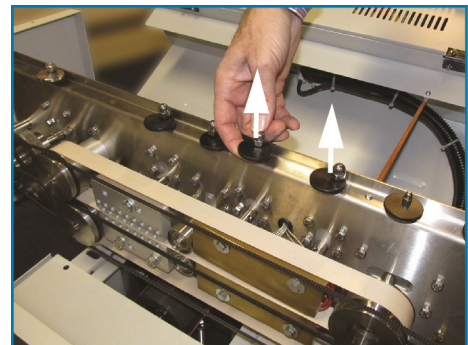

Pull the lifting pin up and turn the lifting plate so that the lifting pin can go back down all the way again.

7.7 Adjusting the Contact Force of the Heating Blocks

The heating blocks can be adjusted as follows:

1. Turn the adjuster nut to alter the contact force.

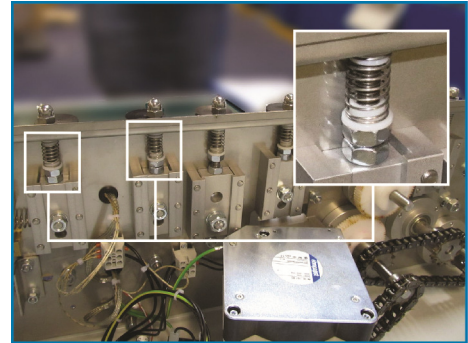

Try to keep the contact force as low as possible in order to minimise wear and tear on the PTFE belts.

If necessary, the contact force can be increased for materials that are difficult to seal. Always check that the bag does not get blocked or stuck during sealing.



Turn anticlockwise to increase the contact force and clockwise to reduce it.



Adjust both nuts equally.

7.8 Adjusting the Contact Force of the Press Rollers

The press rollers can be adjusted as follows:

1. Turn the adjuster nuts to set the contact force.

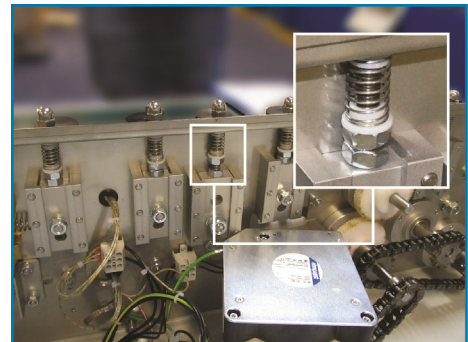

Try to keep the contact force as low as possible in order to minimise wear and tear on the PTFE belts.

If necessary, the contact force can be increased for materials that are difficult to seal. Always check that the bag does not get blocked or stuck during sealing.



Turn anticlockwise to increase the contact force and clockwise to reduce it

7.9 Adjusting the Contact Force for the Cooling Plates

The cooling plates can be adjusted as follows:

1. Turn the adjuster nut to alter the contact force

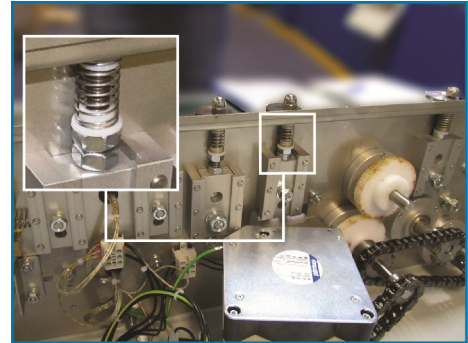

Try to keep the contact force as low as possible in order to minimise wear and tear on the PTFE belts.

If necessary, the contact force can be increased for materials that are difficult to seal. Always check that the bag does not get blocked or stuck during sealing.



Turn anticlockwise to increase the contact force and clockwise to reduce it.

7.10 Adjusting the Contact Force of the After-press Rollers

The after-press rollers can be adjusted as follows:

1. Turn the adjuster nut to alter the contact force.

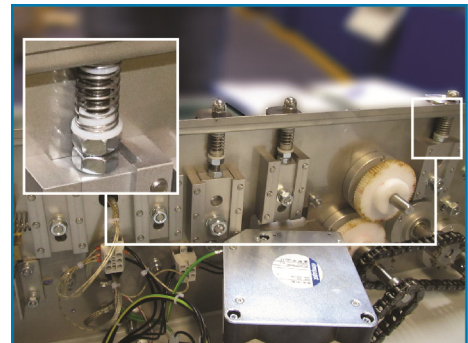

Try to keep the contact force as low as possible in order to minimise wear and tear on the PTFE belts.

If necessary, the contact force can be increased for materials that are difficult to seal. Always check that the bag does not get blocked or stuck during sealing.



Turn anticlockwise to increase the contact force and clockwise to reduce it.

7.11 Adjusting the Conveyor Belt Tension

The conveyor belt can be adjusted as follows:

1. Loosen the two locking nuts on the underside of the conveyor belt a few turns.



2. Turn the tension bolts to adjust the tension.
3. Tighten the two locking nuts again.

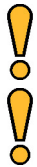
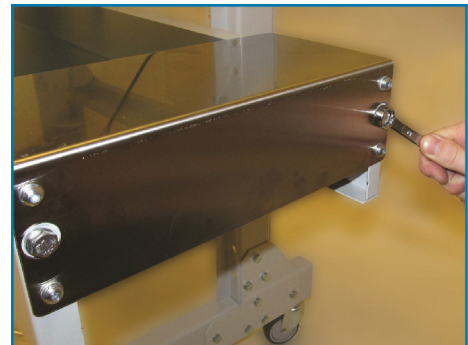

Turn clockwise to increase the conveyor belt tension and anticlockwise to reduce it.

Make sure the tension is the same on both sides so that the conveyor belt is not pulled out of line.

7.12 Motor Set-up

The machine has an automatic motor set-up function. This motor set-up function must be carried out when a motor is replaced. During this set-up the motor will run at full speed for a few seconds. Be aware that the machine can run safely for a few seconds.

To perform a motor set-up follow the next steps:

- Select the 'SPEED' mode with the 'PROG' button.
- Press the 'PROG' button for 5 seconds till 'SP1' appears in the display.
- Start the set-up routine by pressing the 'PROG' button. The motor will run at maximum speed for a few seconds.
- End the function by pressing the 'PROG' button for 5 seconds till the SPEED settings appear on the display.

7.13 Correction factor

The machine has correction factors to adjust the motor if necessary. This factor (%) will affect the motor output. If set at e.g. 90 the motor will run slower and set at e.g. 110 the motor will run faster.

To perform a motor set-up follow the next steps:

- Select the 'SPEED' mode with the 'PROG' button.
- Press the 'MOTOR' and 'PROG' button simultaneous for 5 seconds till 'CF1' appears in the display.
- Press the 'PROG' button.
- Set the CF1 setting with the 'UP' or 'DOWN' button. (Minimum 85 and maximum 115).
- Press the 'PROG' button to return to 'CF1'.
- End the function by pressing the 'PROG' button for 5 seconds till the SPEED settings appear on the display.

7.14 Reset to factory settings

The machine has a function to reset all settings to the original factory settings. Note that if you reset the machine all settings prior made will be lost.

To perform a reset follow the next steps:

- Switch the main power OFF.
- Keep the 'START/STOP'- and the 'PROG' button pressed, while the main power is switched ON, until 'rES' appears in the display.
- Perform a motor set-up.
- Adjust the correction factor if necessary.

8 Disposing of the Sealer



Correct disposal of machines and equipment helps protect the environment and public health.

8.1 WEEE Directive

In accordance with the European Directive on waste electrical and electronic equipment (WEEE), the pictogram shown here indicates that the machine or piece of equipment to which it has been applied is to be collected separately from other waste and may not be disposed of together with other waste.

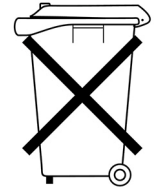

8.2 Correct Disposal for Reuse

The machine or piece of equipment is to be presented to a disposal station or, in case of replacement, to the supplier of the replacement machine or piece of equipment.

For more information, please contact the local agency responsible for the collection of waste and the like, or the municipal waste depot.



The owner of the machine or piece of equipment is responsible for the correct disposal of the machine.

A Technical Information

A.1. Dimension drawing

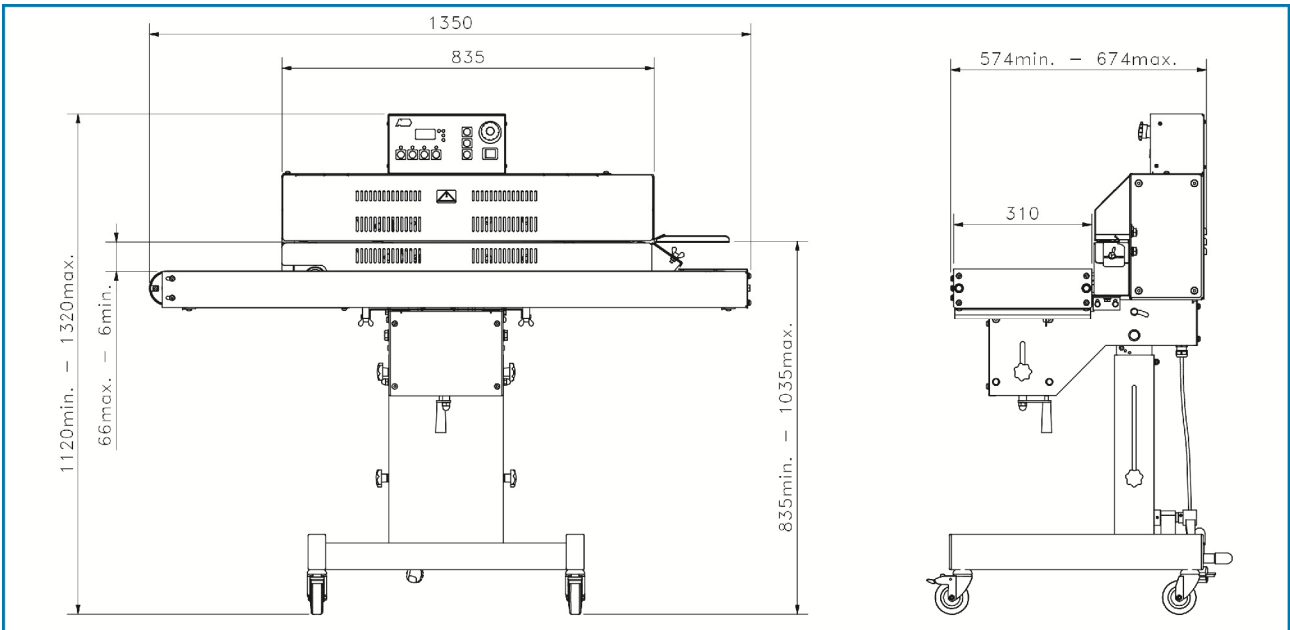
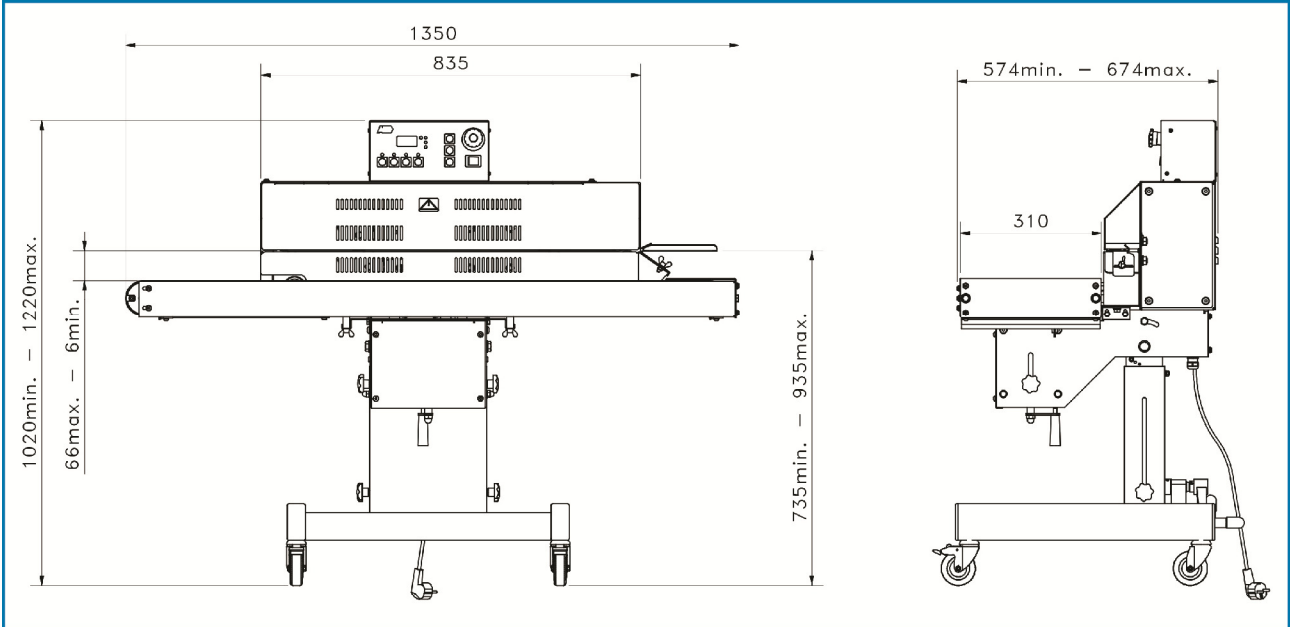

A.2. Technical Data

| | |
|--------------------------------|-------------------------------|
| General | |
| Dimensions | See the dimensional drawing |
| Weight | 93 kg |
| Ambient temperature | 5°C to 40°C |
| Humidity | 30% to 95% RH, non-condensing |
| Seal length | unlimited |
| Seal width | 10 mm |
| Sealing speed | Max. 10 metres per minute |
| IP value | IP20 |
| Electrical | |
| Voltage | 230V - 16A |
| Frequency | 50-60 Hz |
| Earthing | earthed |
| Power | 1100W |
| Mains power tolerance | < 10% |
| Fuse | 4 AT |
| Length of power cable | ± 1.8 m |
| Film | |
| Min. film thickness | 20µm |
| Max. film thickness | 150µm |
| Max. film insert | 40 mm |
| Max. film width | unlimited |
| Bag dimensions | |
| Max. weight (on conveyor belt) | 10 kg |
| Max. bag length | 420 mm |
| Max. volume | unlimited |
| Emissions | |
| Noise | < 70 dB(A) |
| Hand/arm vibration | <2.5 m/s ² |

B Electrical Diagram



Maintenance to the electrical installation should only be performed by authorised maintenance personnel.



Always remove the plug from the socket before carrying out any maintenance work.

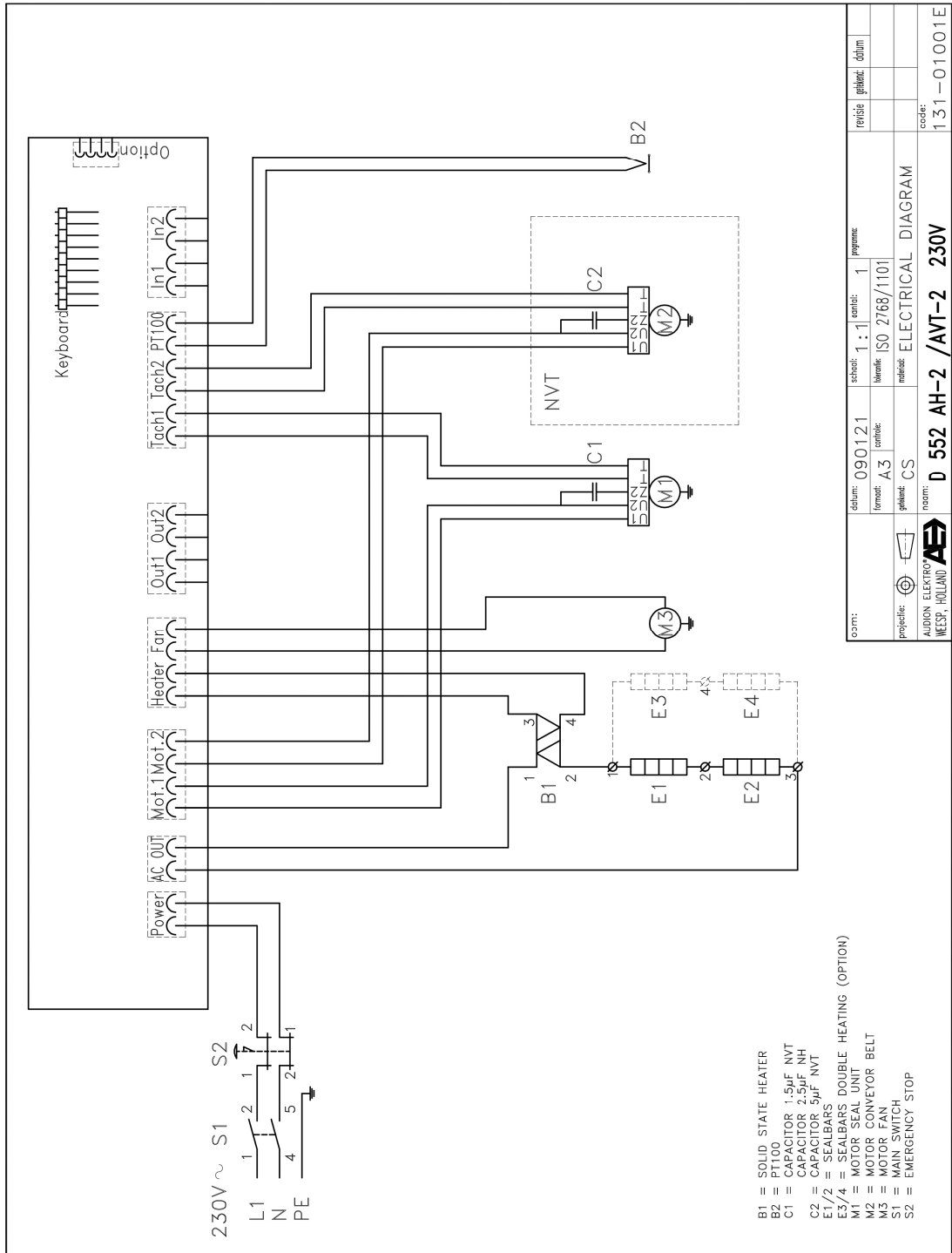

All-In Sealer

D 552 AH / D 552 AHS

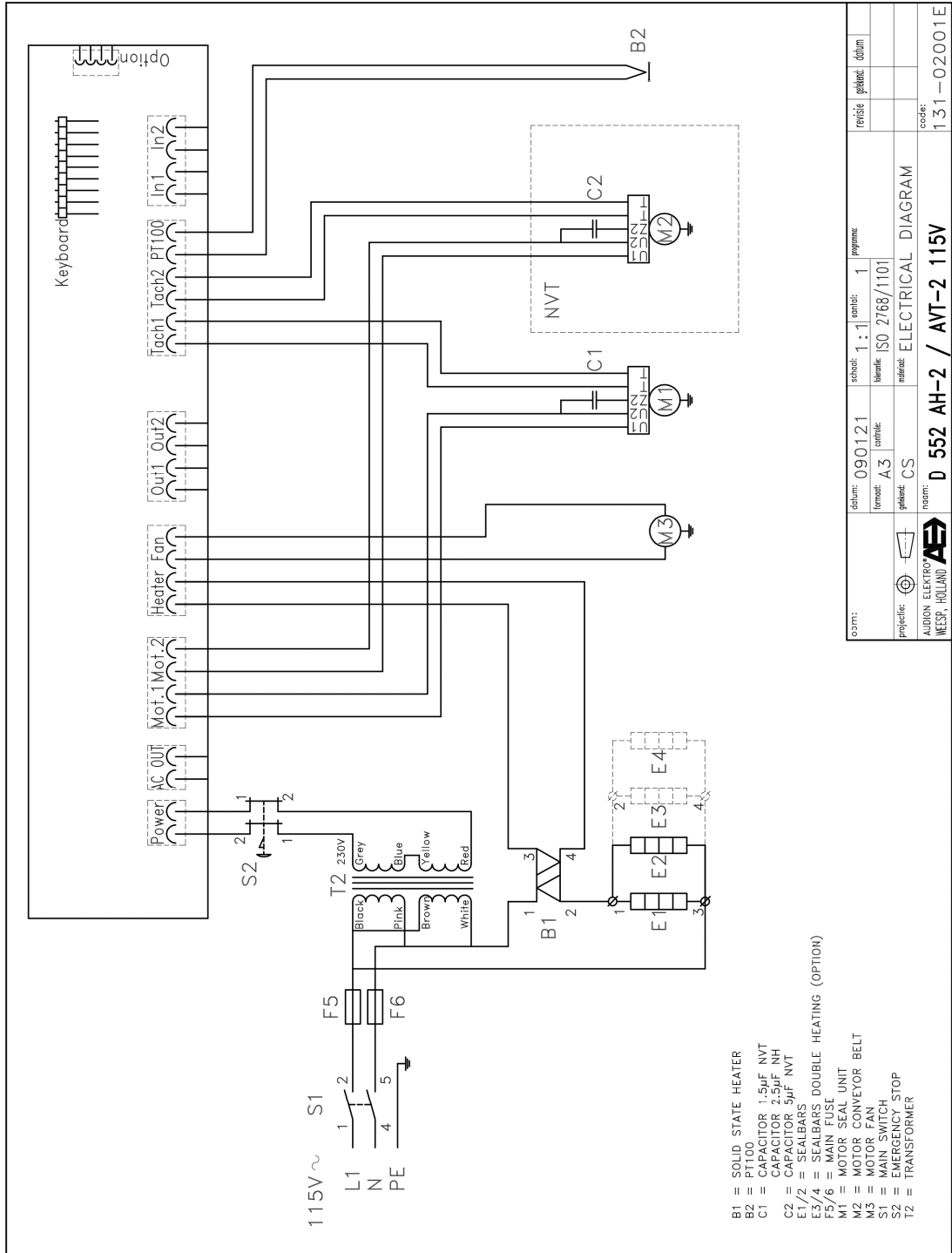

C Spare Parts



Only use original Audion parts for repairs and maintenance.



Repairs and maintenance should only be performed by authorised maintenance personnel.



Always keep a set of recommended wear parts in stock so that a defective part can be replaced quickly and the production process resumed without delay.

C.1. Wearing parts

| Part | Qty per machine | Item number |
|---|-----------------|-------------|
| V-belt, large | 2 | 685216-14 |
| V-belt, small | 2 | 685205-11 |
| PTFE belt, width 25 mm | 2 | 685206-20 |
| Heating element | 2 | 685209-11 |
| Set of wear-and-tear parts 2x V-belt, large 2x V-belt, small 4x PTFE belt, width 25 mm 2x heating element | | 131-1202 |

C.2. Exploded views

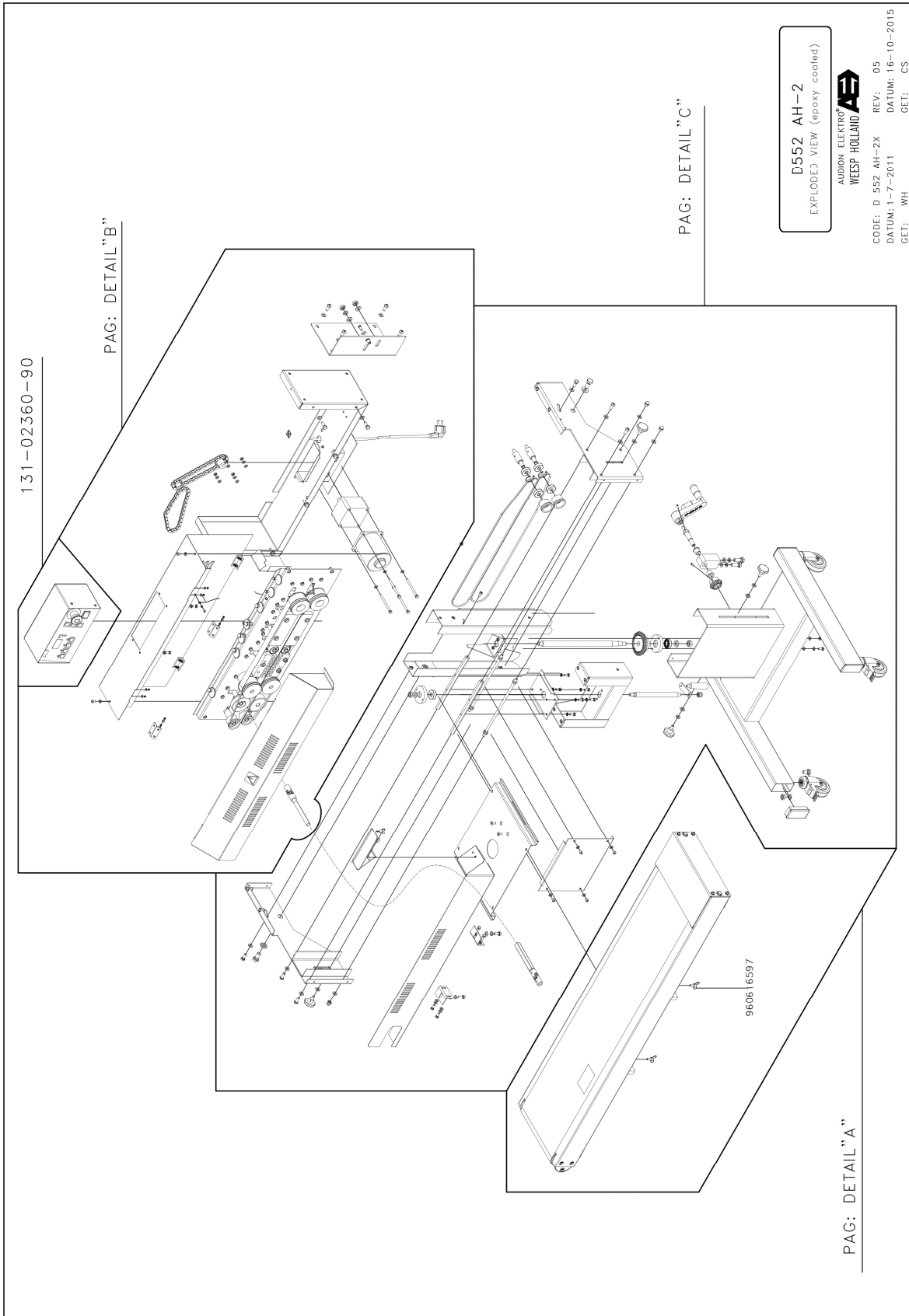

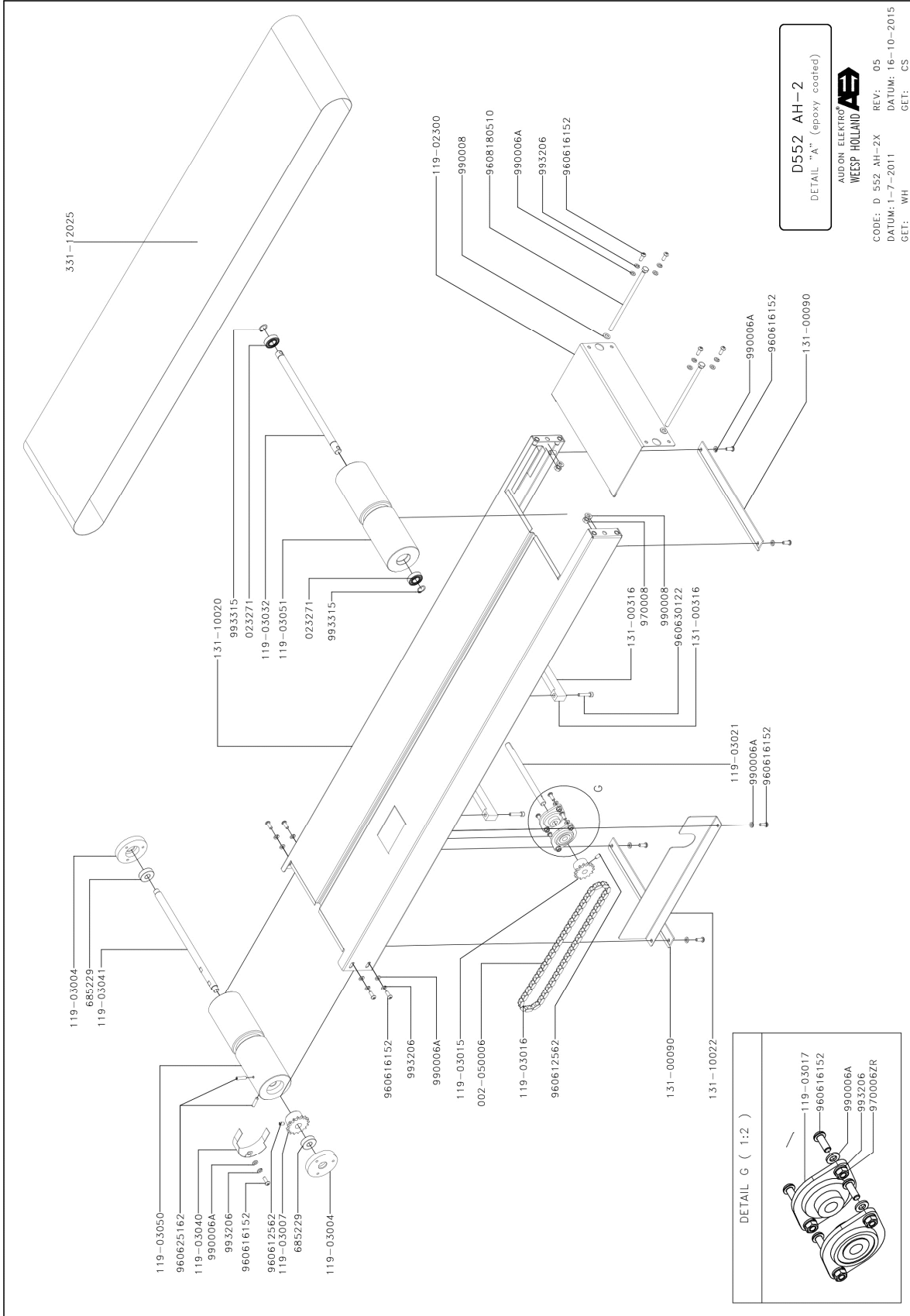

All-In Sealer

D 552 AH / D 552 AHS

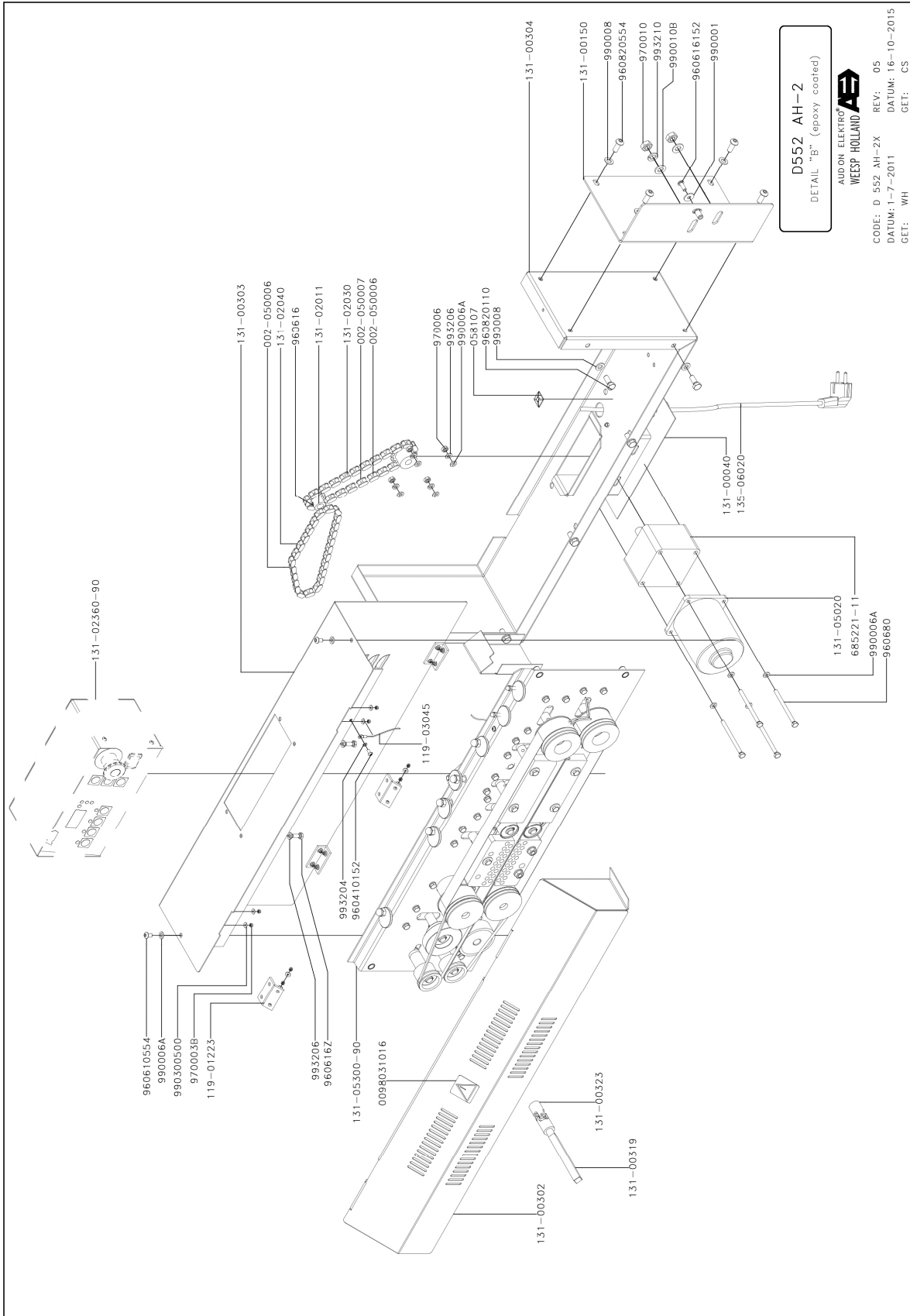

D552 AH-2
DETAIL "B" (epoxy coated)

AUDION ELEKTRO
WEESP HOLLAND

CODE: D 552 AH-2X REV: 05
DATUM: 1-7-2011 DATUM: 16-10-2015
GET: WH GET: CS

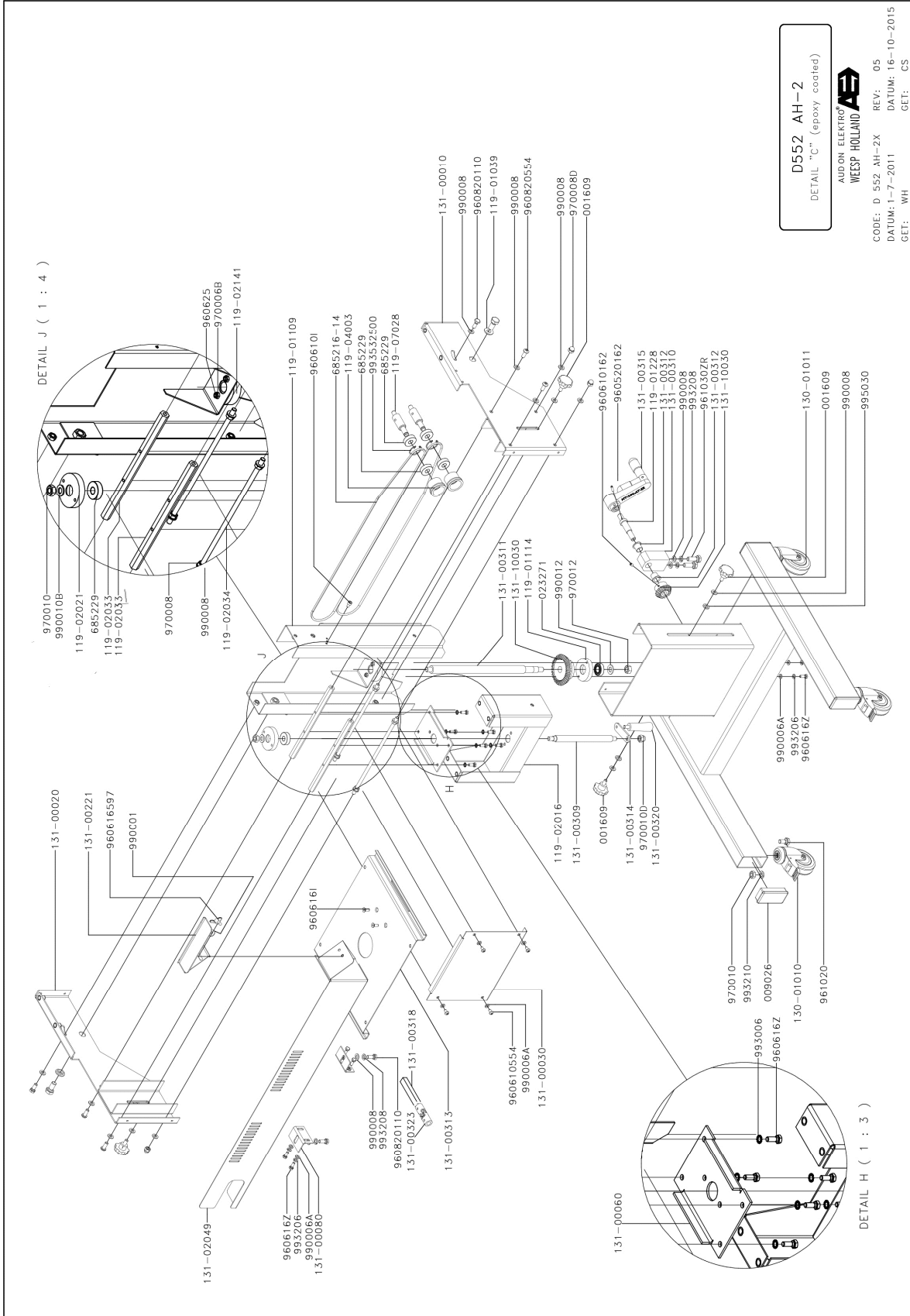

All-In Sealer

D 552 AH / D 552 AHS

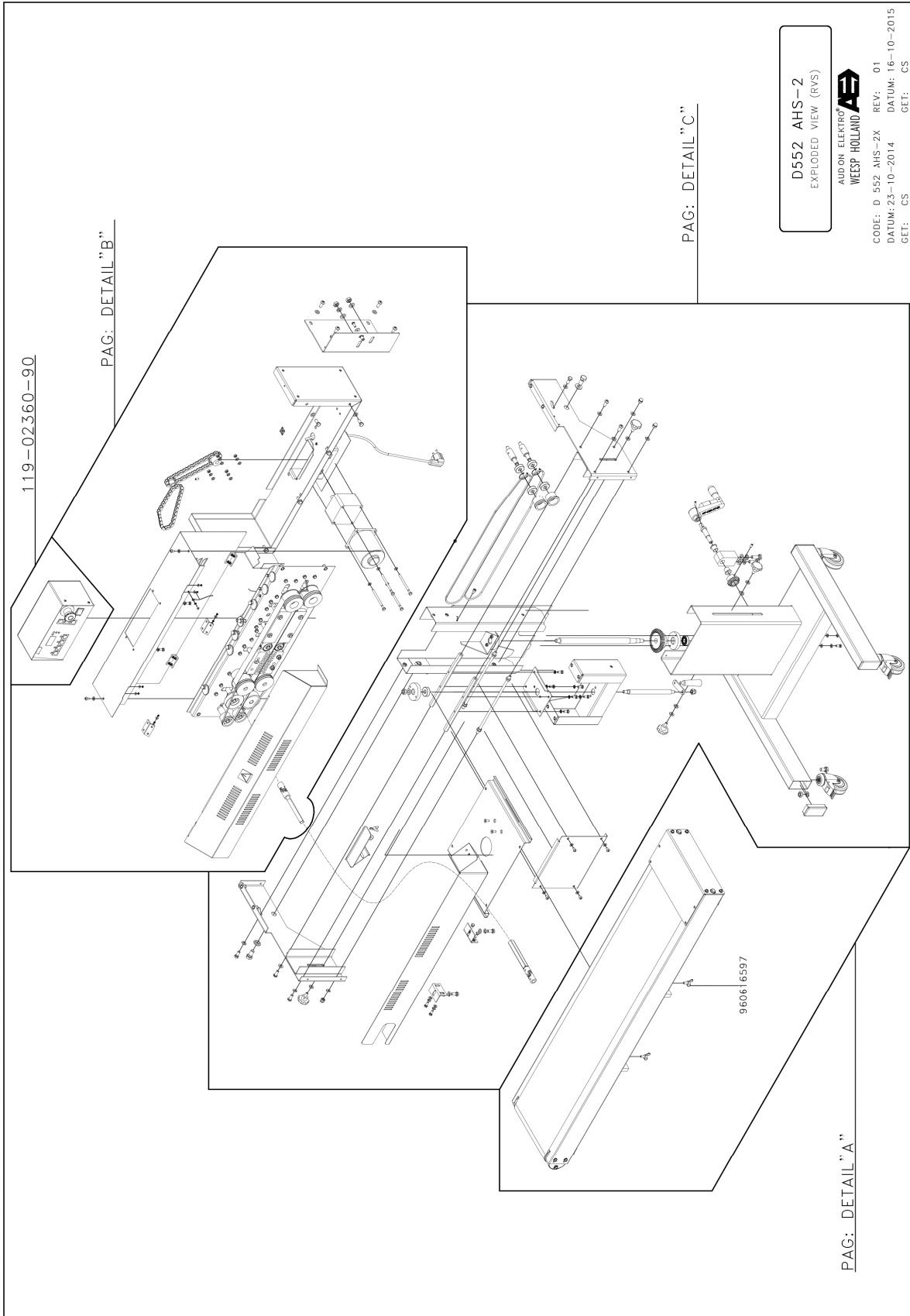

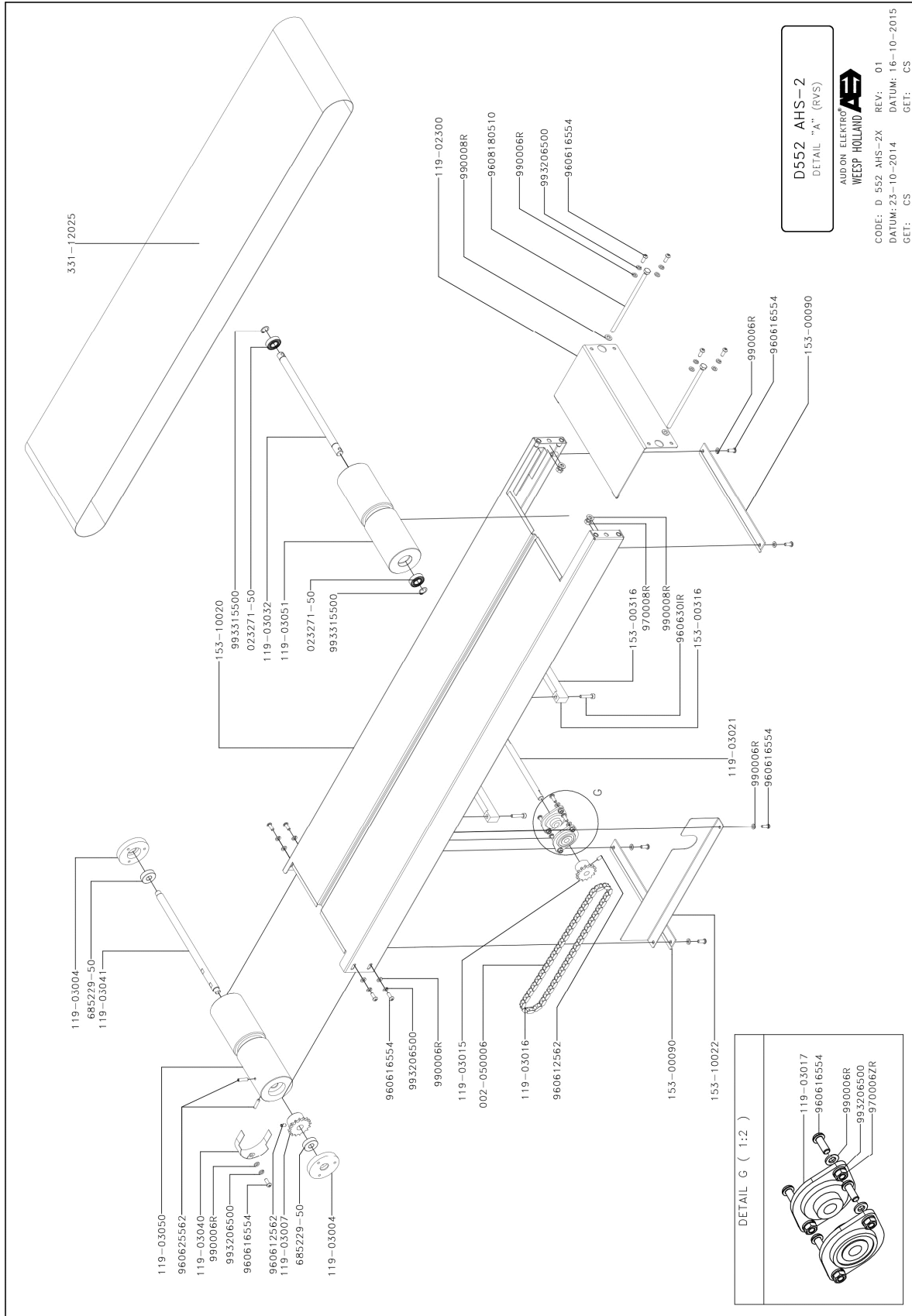

All-In Sealer

D 552 AH / D 552 AHS

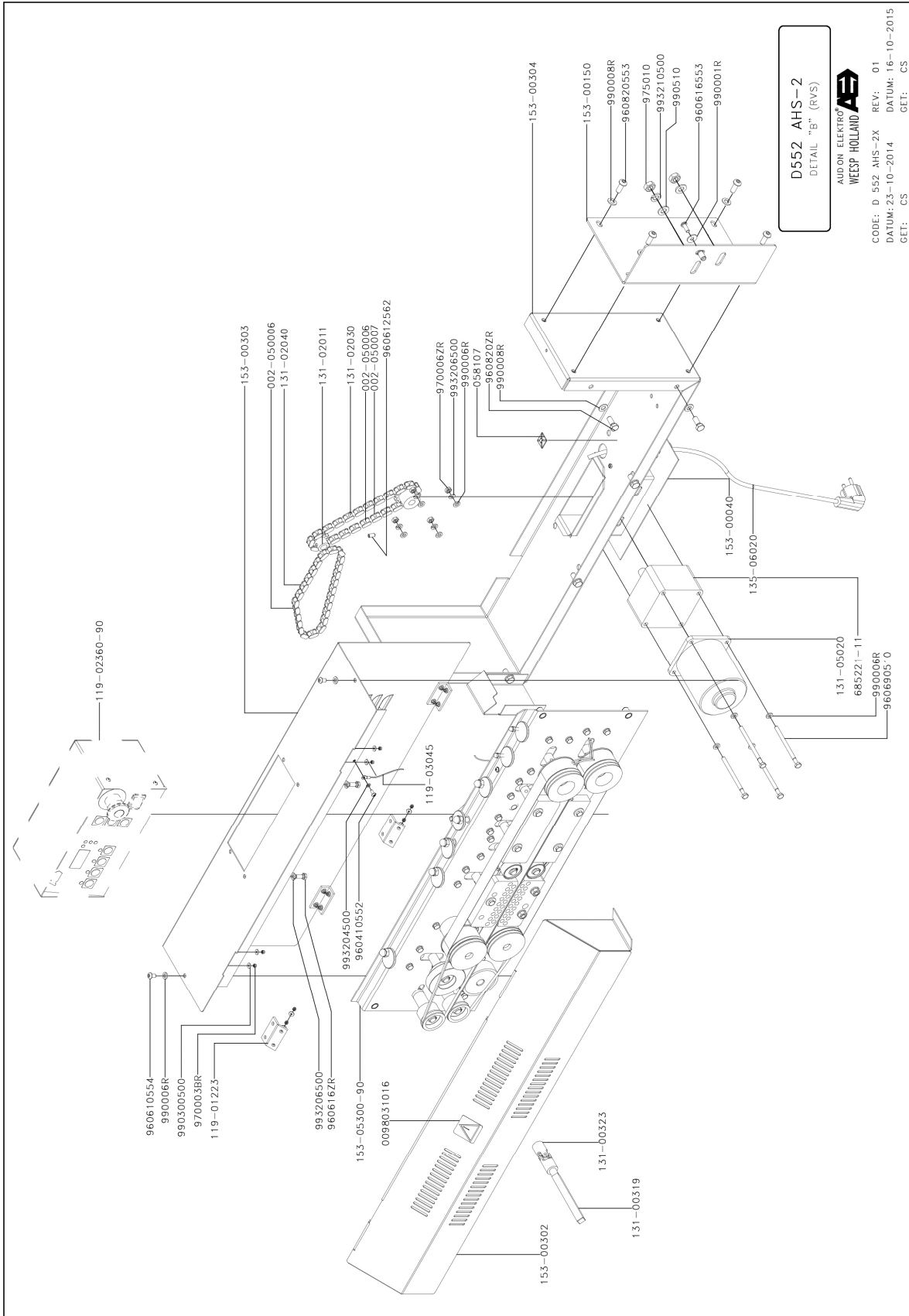

D552 AHS-2
DETAIL "B" (RVS)



AUDON ELEKTRO
WEESP HOLLAND
CODE: D 552 AHS-2X REV: 01
DATUM: 23-10-2014 DATUM: 16-10-2015
GET: CS GET: CS

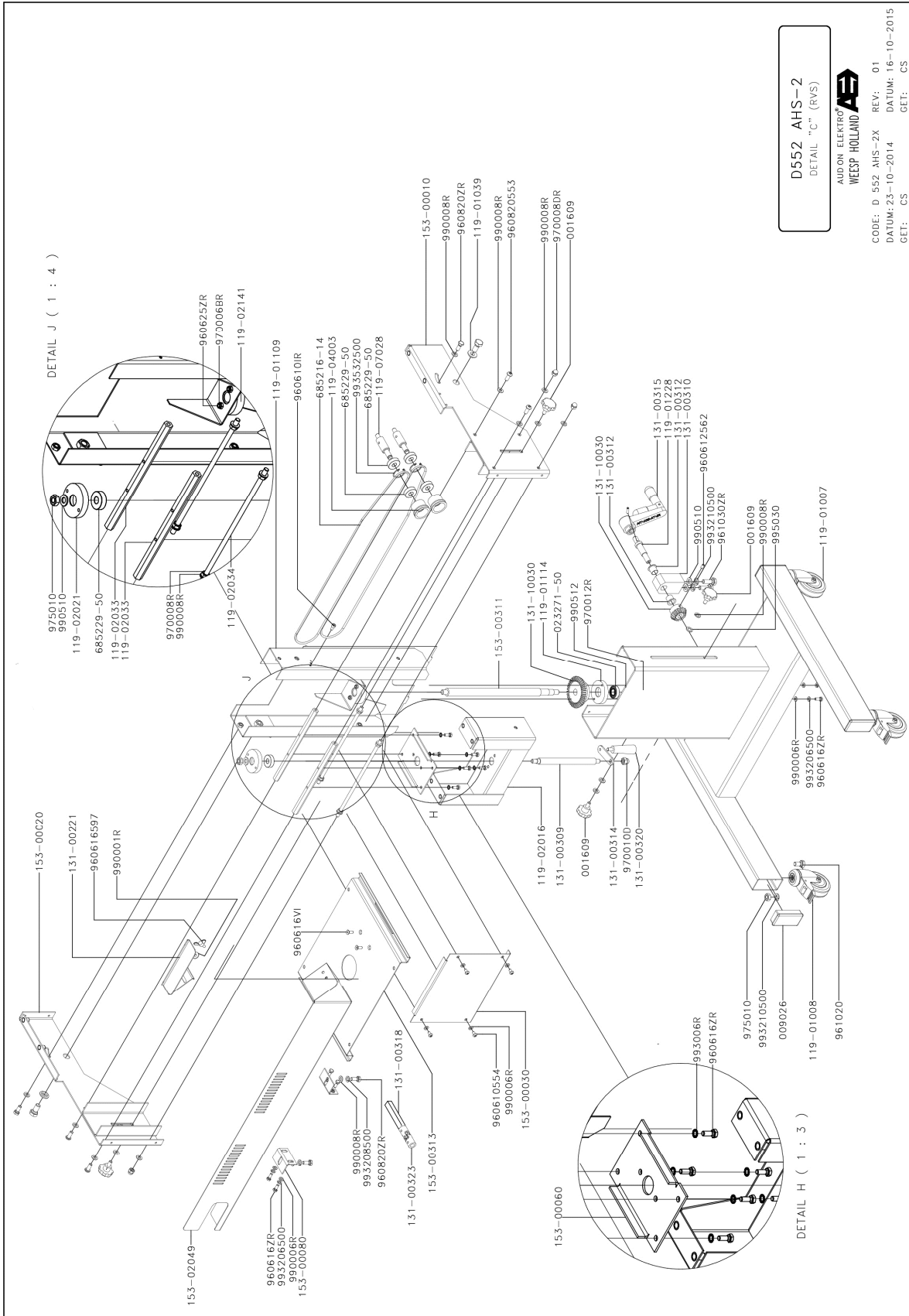

All-In Sealer

D 552 AH / D 552 AHS

DETAIL D (1:1:2)

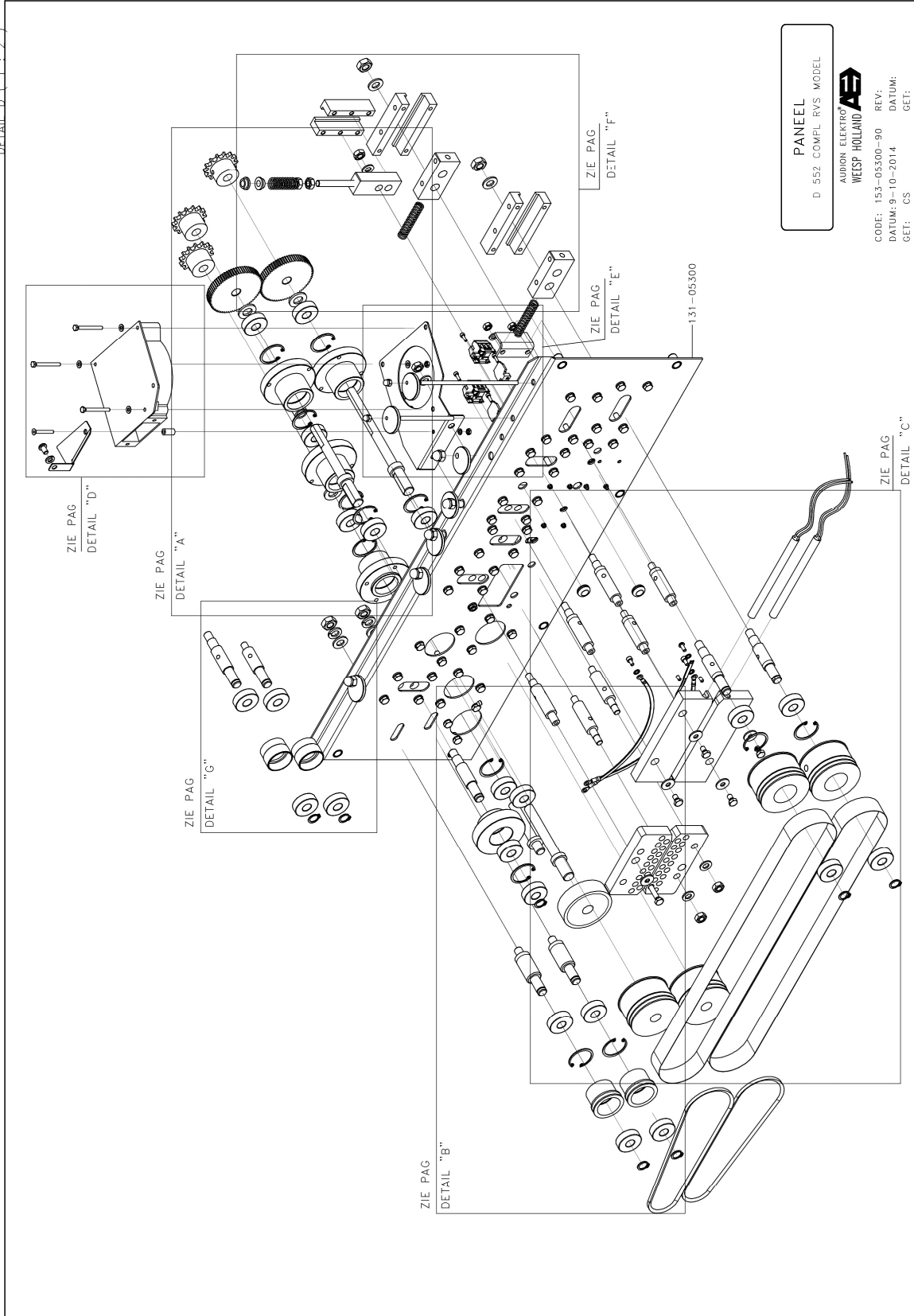

PANEEL
D 552 COMPL RVS MODEL



CODE: 153-05300-90 REV:
DATUM: 9-10-2014 DATUM:
GET: CS GET:

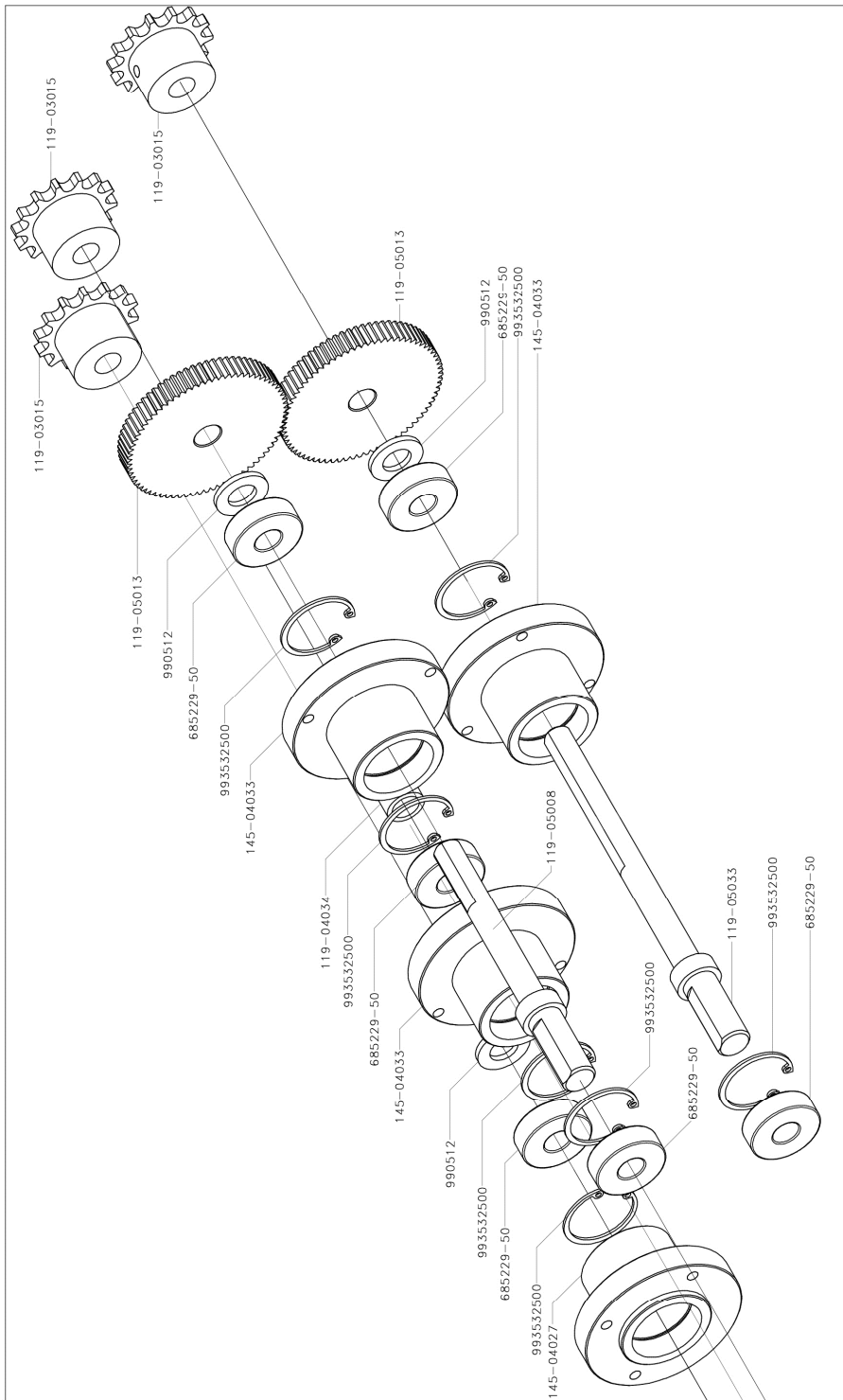

DETAIL "A"



AUDION ELEKTRO
WEESP HOLLAND

CODE: 153-05300-90 REV:
DATUM: 9-10-2014 DATUM:
GET: CS GET:

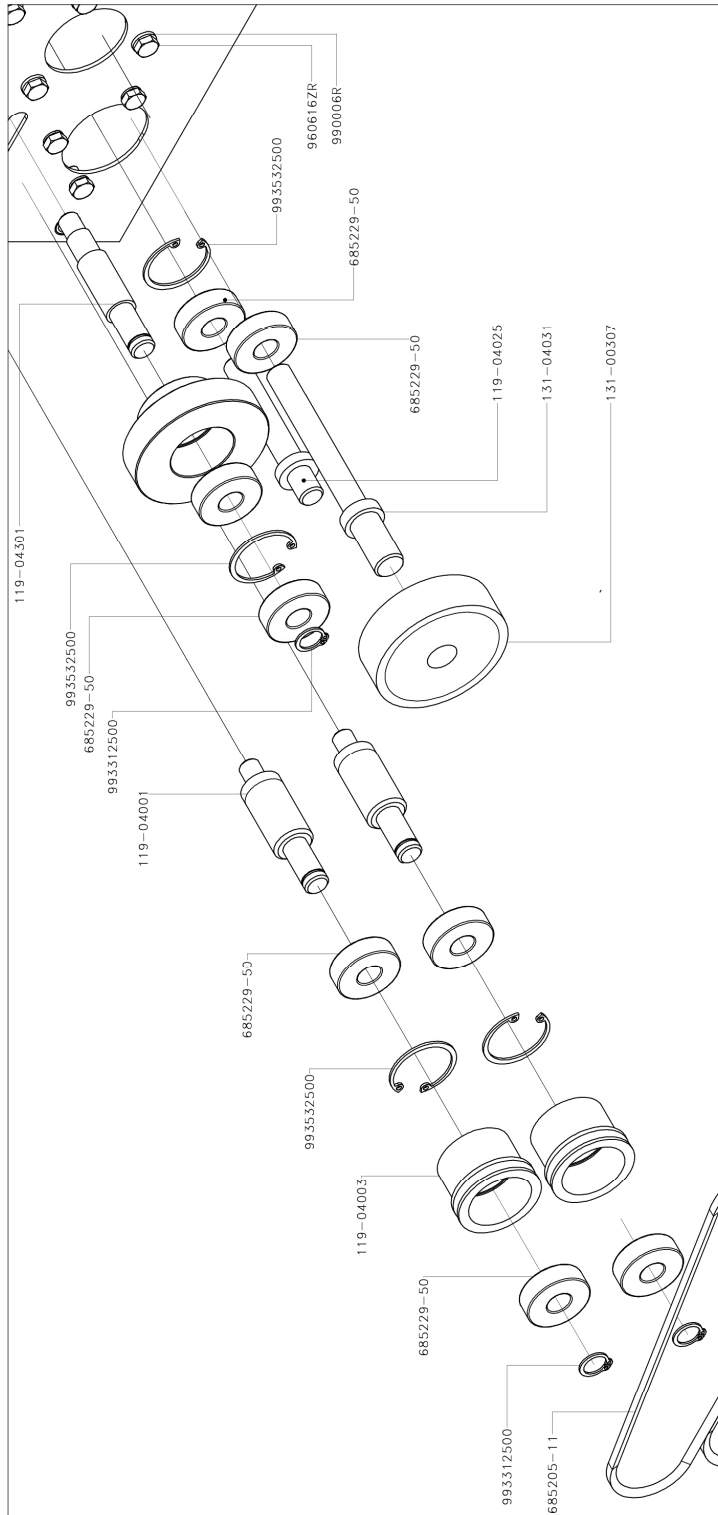

DETAIL "B"



CODE: 153-05300-90 REV:
 DATUM: 9-10-2014 DATUM:
 GET: CS GET:

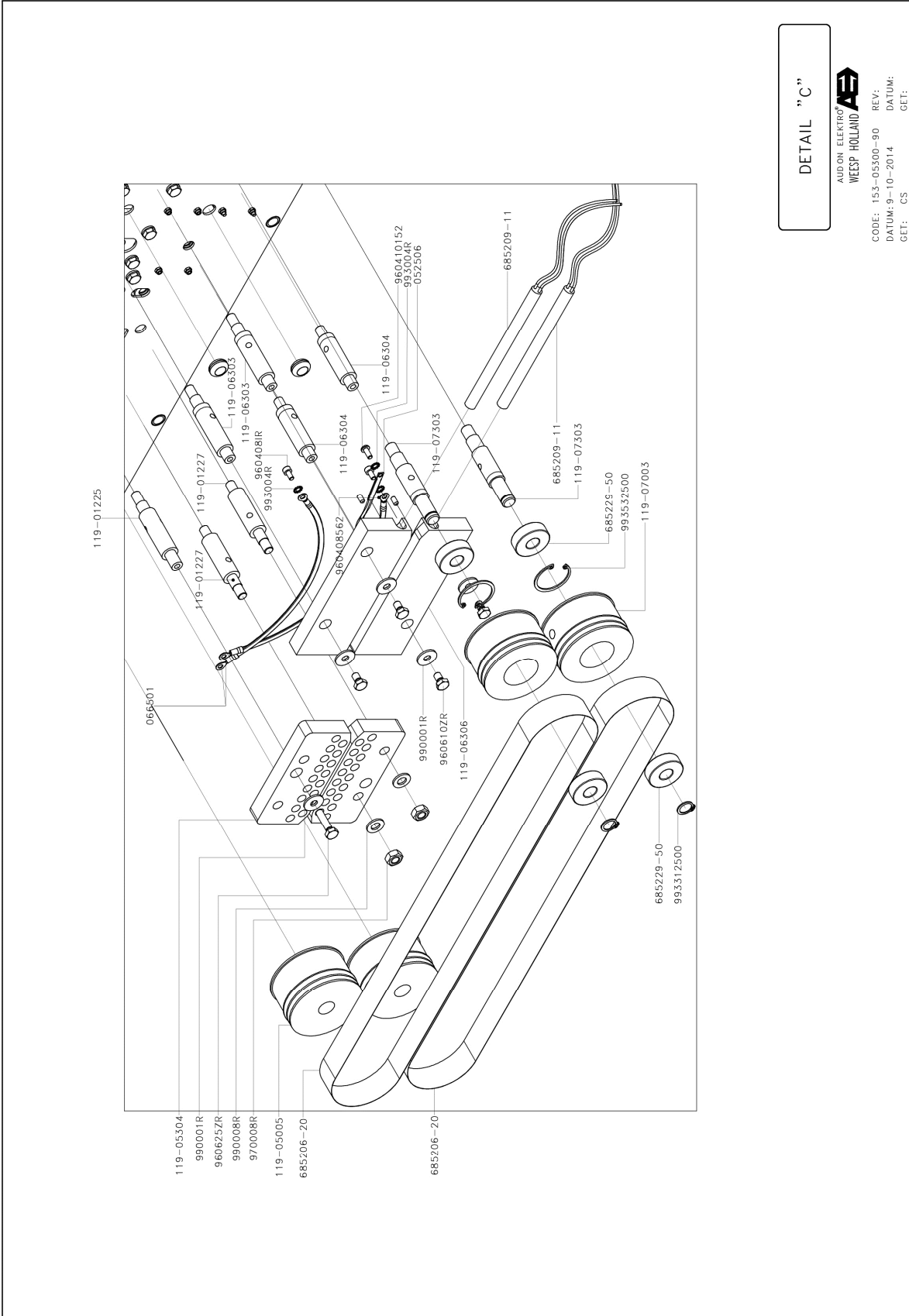

All-In Sealer

D 552 AH / D 552 AHS

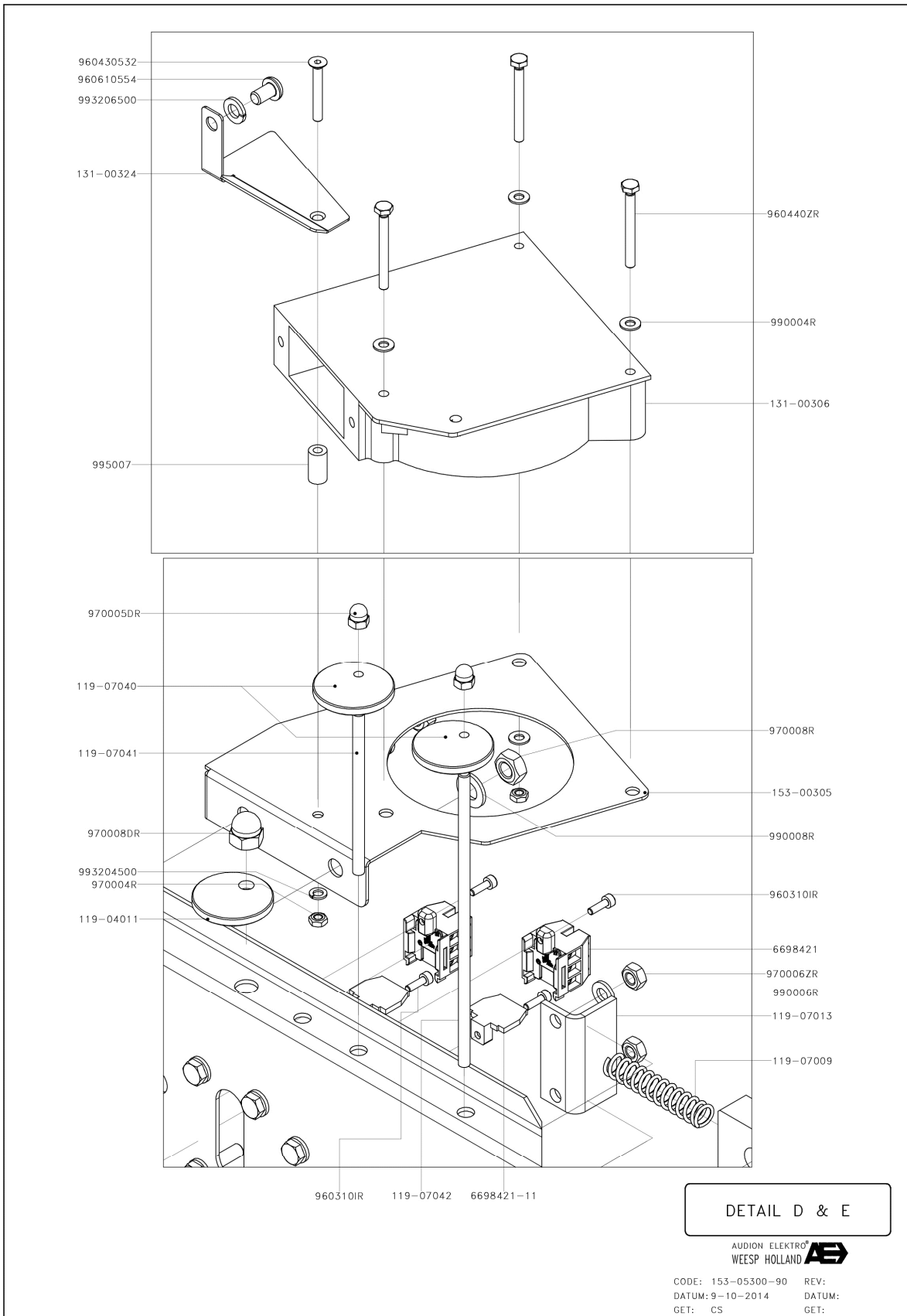

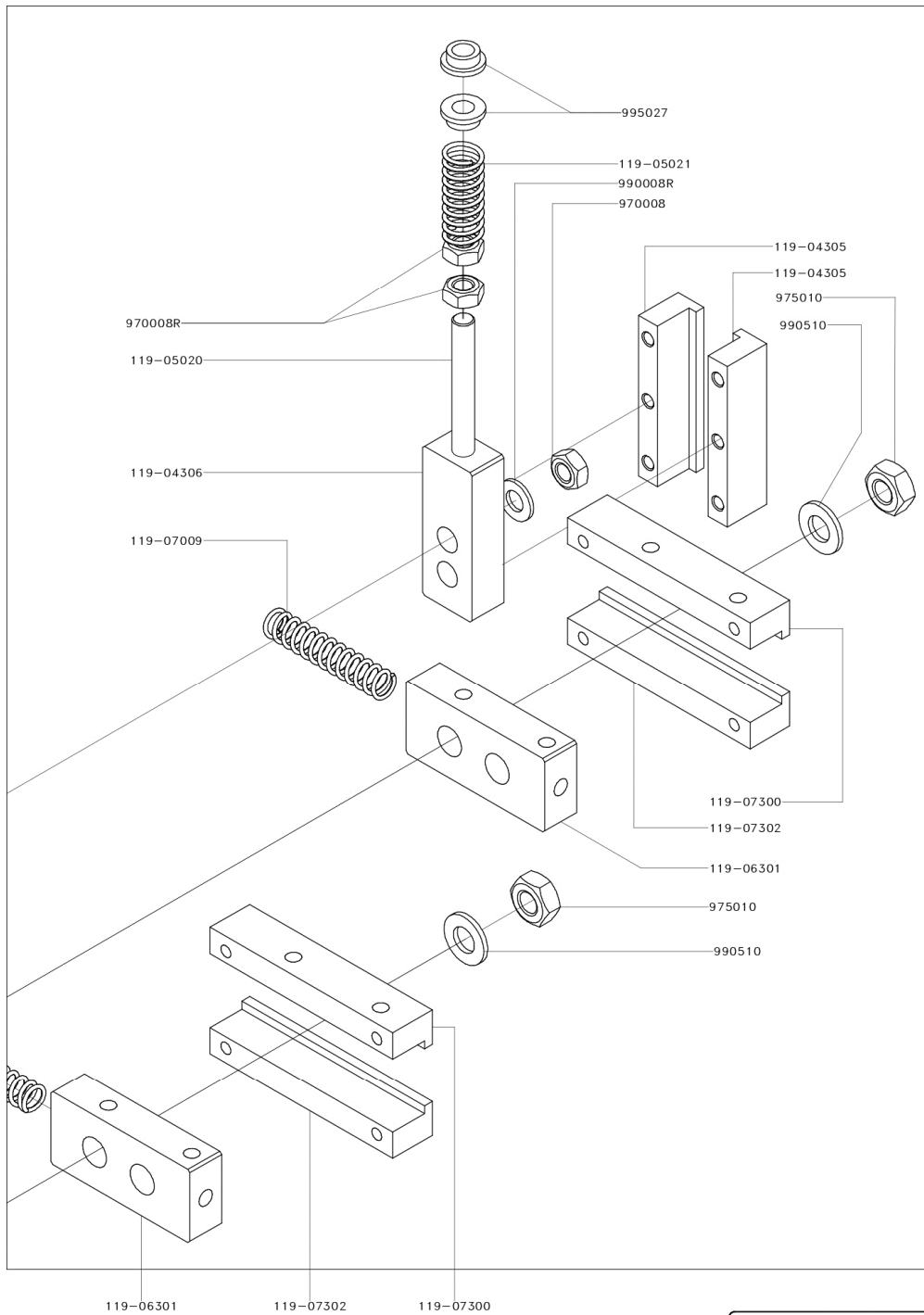

DETAIL "F"

AUDION ELEKTRO®
WEESP HOLLAND **AE**

CODE: 153-05300-90 REV:
DATUM: 9-10-2014 DATUM:
GET: CS GET:

All-In Sealer

D 552 AH / D 552 AHS

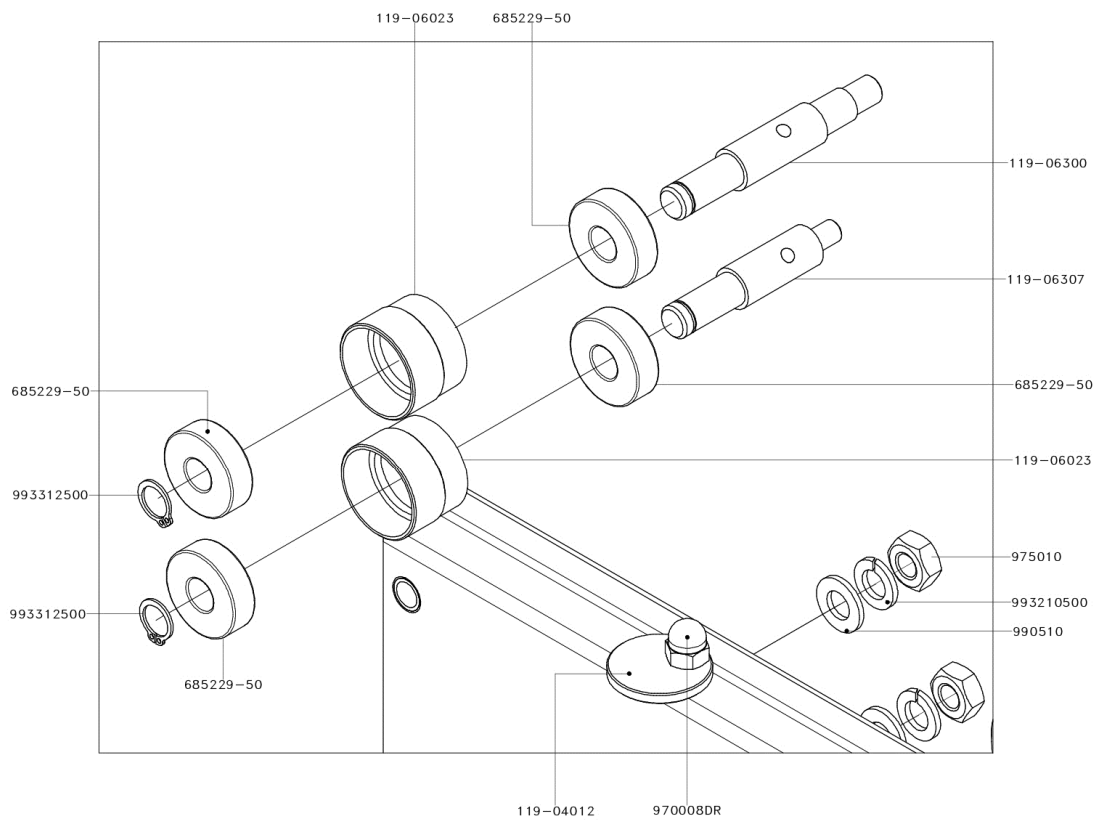

DETAIL "G"

AUDION ELEKTRO®
WEESP HOLLAND 

CODE: 153-05300-90 REV:
DATUM: 9-10-2014 DATUM:
GET: CS GET:

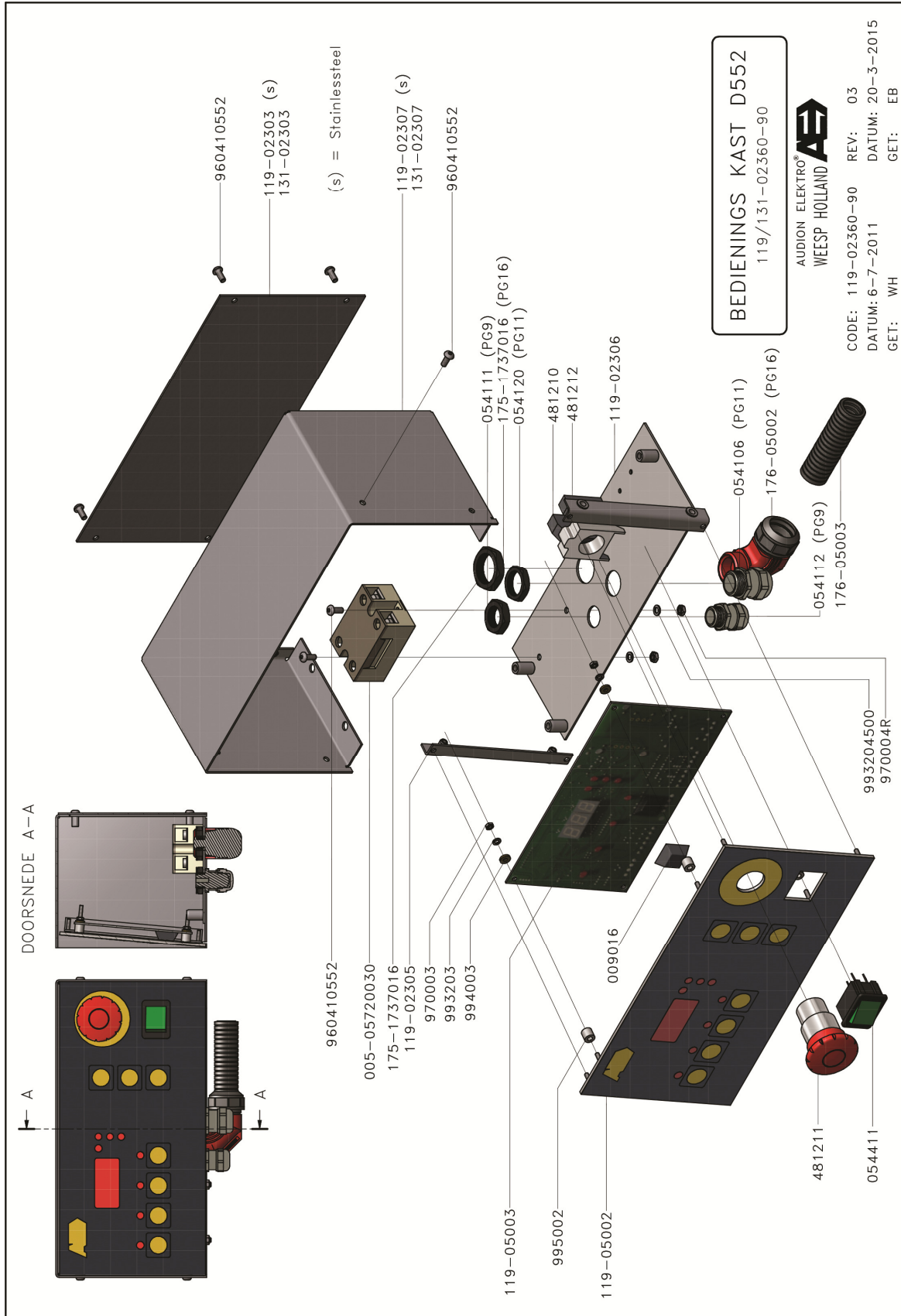

D Log



Always keep a log of all maintenance work.



Refer to the 'Maintenance' chapter for an overview of the maintenance work to be carried out.



Make a copy of the log and use it to sign off the maintenance work.

D.1. Maintenance Log

| Maintenance* | Remarks/parts replaced | Date | Performed by | Initials |
|--|------------------------|------|--------------|----------|
| Weekly/ Monthly | | | | |
| Weekly/ Monthly | | | | |
| Weekly/ Monthly | | | | |
| Weekly/ Monthly | | | | |
| Weekly/ Monthly | | | | |
| Weekly/ Monthly | | | | |
| Weekly/ Monthly | | | | |
| Weekly/ Monthly | | | | |
| Weekly/ Monthly | | | | |
| *Strike out that which does not apply. | | | | |

E EC Declaration**EC-DECLARATION OF CONFORMITY**

AUDION ELEKTRO B.V., located at the Hogeweyselaan 235 in
Weesp, The Netherlands

herewith declares that the

ALL IN SEALER 552

Type:

D 552 AH(S)-2 ; D 552 AVT(S)-2

- is in conformity with the provisions of the following EEC directives:
2006/42/EC Machine Directive ; 2014/30/EU EMC-Directive ; RoHS
2011/65/EU Directive ;

- and that the following (parts/clauses of) harmonized standards have been
applied:

EN-ISO 12100; EN-ISO 13732-1; EN-ISO 13850; EN 1037+A1; EN-IEC
60204-1;

Weesp, 21-6-2018

E.Tangelder

Director



PGR139B

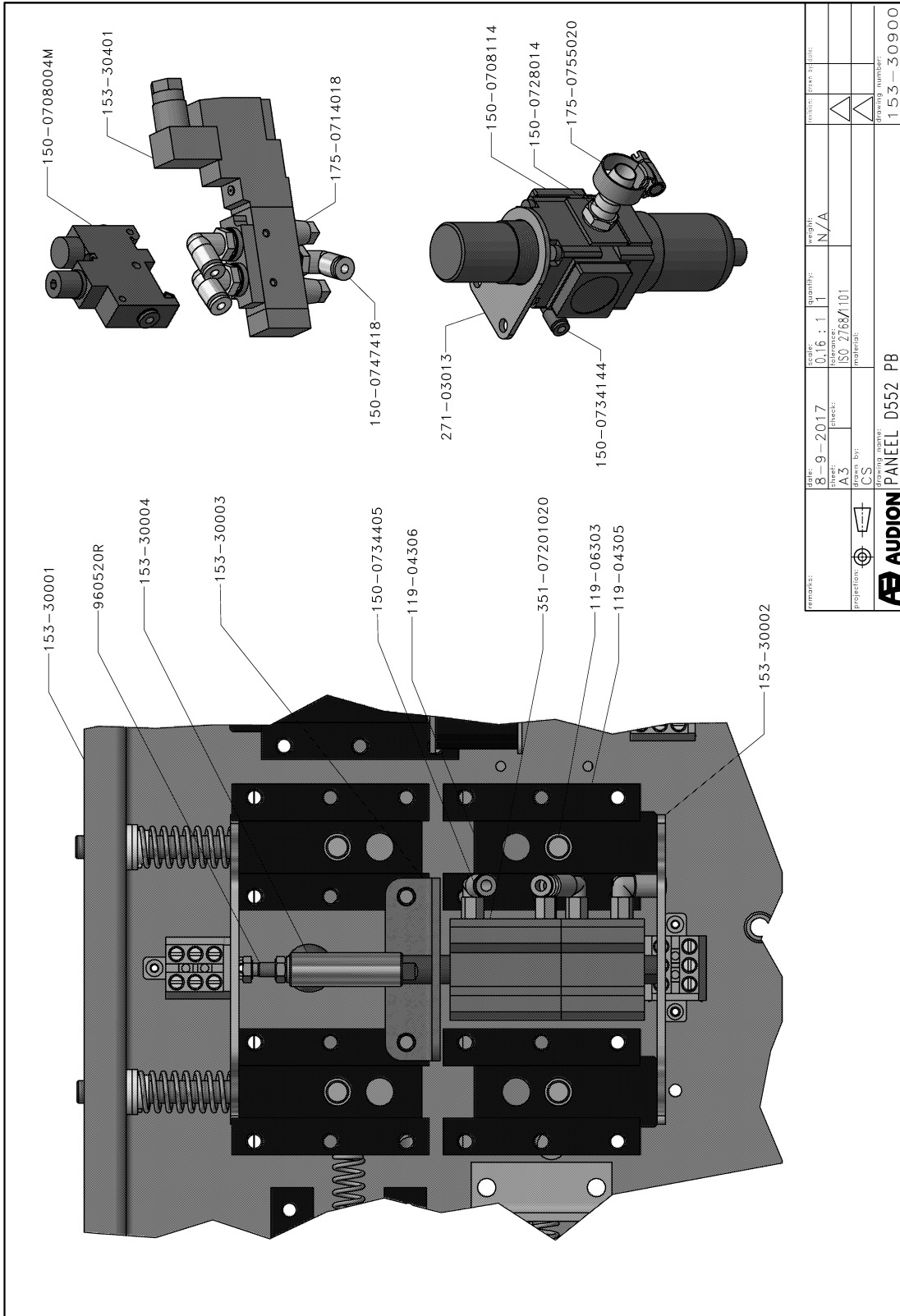

Audion Elektro BV
Hogeweyselaan 235
1382 JL Weesp
The Netherlands
Tel +31 (0)294 491717
Fax +31 (0)294 491761
Email holland@audion.nl
www.audion.com

Represented by: